

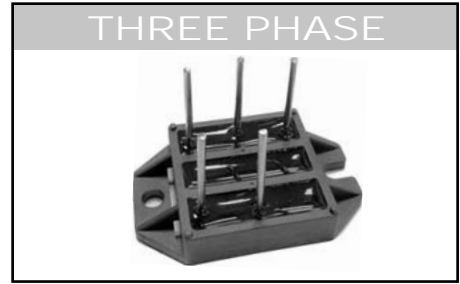

THREE PHASE STANDARD RECOVERY BRIDGE 86A

Preliminary



Features

- High Surge Capability
- Types up to 1600V V_{RRM}
- Isolation Type Package

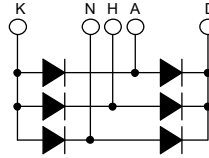

Dimensions in mm (1 mm = 0.0394")

Maximum Ratings

- Junction Operating Temperature : -40°C to +150°C
- Storage Temperature : -40°C to +125°C

Part Number	Maximum Recurrent Peak Reverse Voltage	Maximum DC Blocking Voltage
DAR3PV086-160W	1600V	1600V

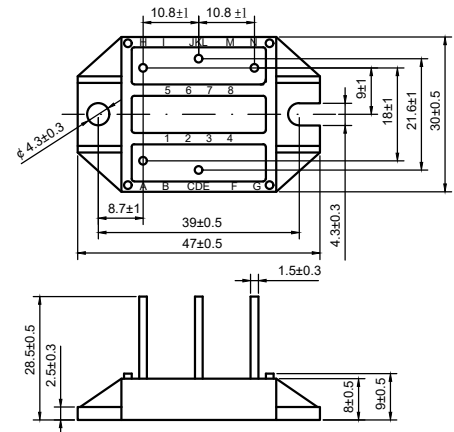

Electrical Characteristics @ 25°C Unless Otherwise Specified

Definition	Conditions	Symbol	min.	typ.	max.	Unit
Bridge output current	$T_c = 90^\circ\text{C}$, per module $T_{vj} = 150^\circ\text{C}$	I_{DAV}			90	A
Max. forward surge current	$t = 10\text{ ms}$; (50 Hz), $T_{vj} = 45^\circ\text{C}$ sine $t = 8,3\text{ ms}$; (60 Hz), sine $V_R = 0\text{ V}$	I_{FSM}			550 595	A A
	$t = 10\text{ ms}$; (50 Hz), $T_{vj} = 150^\circ\text{C}$ sine $t = 8,3\text{ ms}$; (60 Hz), sine $V_R = 0\text{ V}$				470 505	A A
Value for fusing	$t = 10\text{ ms}$; (50 Hz), sine $T_{vj} = 45^\circ\text{C}$ $t = 8,3\text{ ms}$; (60 Hz), sine $V_R = 0\text{ V}$	I^2t			1.52 1.48	kA^2s kA^2s
	$t = 10\text{ ms}$; (50 Hz), sine $T_{vj} = 150^\circ\text{C}$ $t = 8,3\text{ ms}$; (60 Hz), sine $V_R = 0\text{ V}$				1.11 1.06	kA^2s kA^2s
Reverse current	$V_R = 1600\text{ V}$ $T_{vj} = 25^\circ\text{C}$ $V_R = 1600\text{ V}$ $T_{vj} = 150^\circ\text{C}$	I_R			40 1.5	μA mA
Forward voltage drop	$I_F = 80\text{ A}$ $T_{vj} = 25^\circ\text{C}$	V_F			1.5	V
Threshold voltage for power loss calculation only	$T_{vj} = 150^\circ\text{C}$	V_{F0}			0.8	V
		r_F			7.8	m Ω
Total power dissipation	$T_c = 25^\circ\text{C}$	P_{tot}			135	W
Junction capacitance	$V_R = 400\text{ V}$; $f = 1\text{ MHz}$ $T_{vj} = 25^\circ\text{C}$	C_J		20		pF
Creepage distance on surface and Striking distance through air	terminal to terminal terminal to backside	$d_{Spp/App}$	6.0			mm
		$d_{Spb/Appb}$	10.0			mm
Isolation voltage	50/60 Hz, RMS; $I_{ISOL} \leq 1\text{ mA}$ $t = 1\text{ second}$ $t = 1\text{ minute}$	V_{ISOL}	3000 2500			V V
Thermal resistance junction to case		R_{thJC}			0.9	K/W
Thermal resistance case to heatsink		R_{thCH}		0.4		K/W
Mounting torque		M_D	1.4		2	Nm



Figure .1- Typical Forward Characteristics

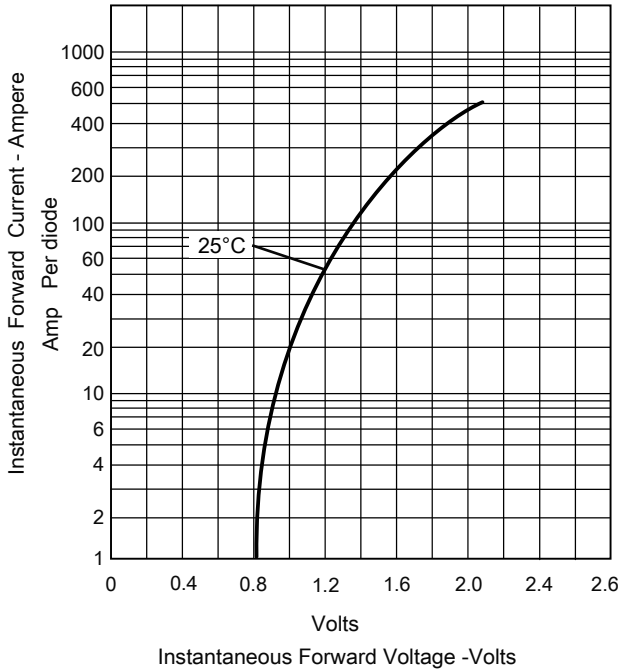

Figure .2-Bridge Output Current Curve

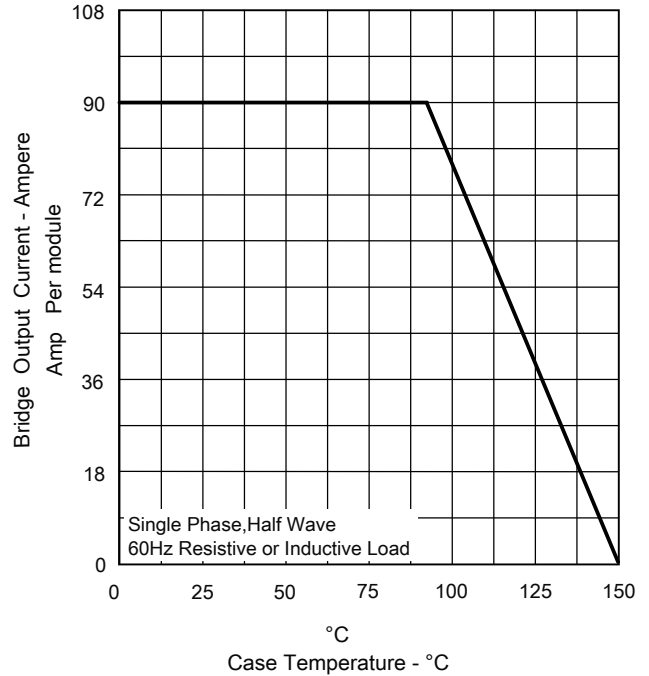

Figure .3- Peak Forward Surge Current

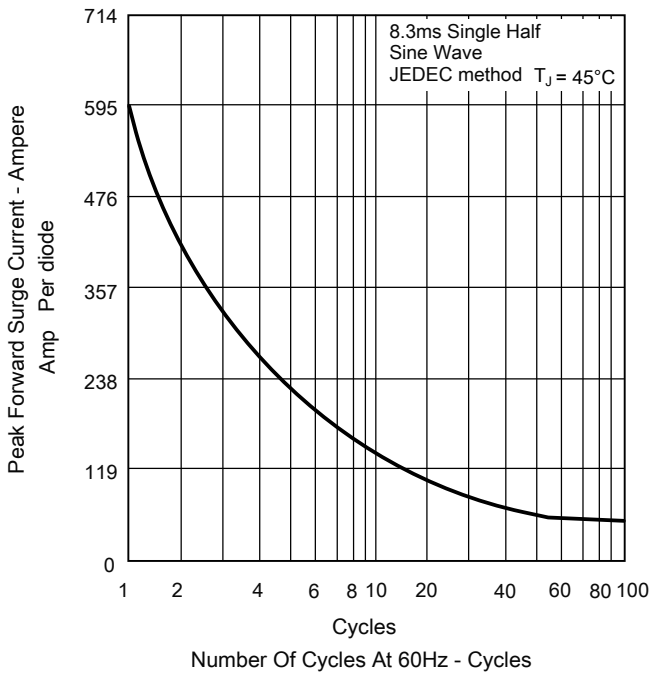
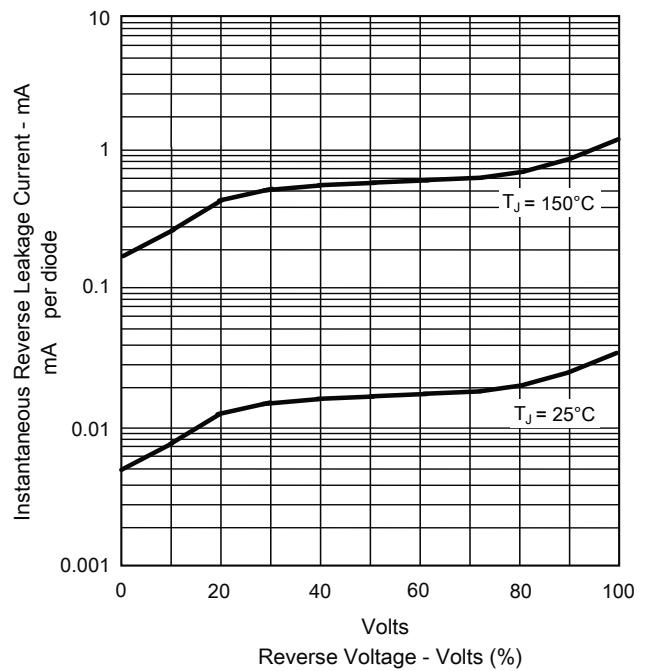

Figure .4 -Typical Reverse Characteristics





Disclaimer

DACO Semiconductor reserve the right to make modifications, enhancements, improvements, corrections or other changes without further notice to this document and any product described herein.

DACO Semiconductor makes no warranty, representation or guarantee regarding the suitability of its products for any particular purpose, nor does DACO Semiconductor assume any liability arising out of the application or use of any product or circuit, and specifically disclaims any and all liability, including without limitation special, consequential or incidental damages.

Purchasers is responsible for its products and applications using DACO Semiconductor products, including compliance with all laws, regulations and safety requirements or standards, regardless of any support or applications information provided by DACO Semiconductor. "Typical" parameters which may be provided in DACO Semiconductor data sheets and/or specifications can and do vary in different applications and actual performance may vary over time. All operating parameters, including "Typicals" must be validated for each customer application by customer's technical experts.

DACO Semiconductor products are not designed, authorized or warranted to be suitable for use in life support, life-critical or safety-critical systems or equipment, nor in applications where failure or malfunction of DACO Semiconductor's product can reasonably be expected to result in personal injury, death or severe property or environmental damage. DACO Semiconductor accept no liability for inclusion and/or use of DACO Semiconductor's products in such equipment or applications and therefore such inclusion and/or use is at the customer's own risk.

Purchasers buy or use DACO Semiconductor products for any such unintended or unauthorized application, Purchasers shall indemnify and hold DACO Semiconductor and its suppliers and distributors harmless against all claims, costs, damages, and expenses, and reasonable attorney fees arising out of, directly or indirectly, any claim of personal injury or death associated with such unintended or unauthorized use, even if such claim alleges that DACO Semiconductor was negligent regarding the design or manufacture of the part.

No part of this publication may be reproduced or transmitted in any form or by any means, electronic or mechanical, including photocopying and recording, or any information storage or retrieval system, or otherwise, without the prior written permission of DACO Semiconductor Co., Ltd.