

AMED60-GY



DIN Rail

The AMED60-GY is a slim DIN-rail mounting AC/DC converter that features a cost-effective and energy efficient design. It accepts an input voltage range of 90-264VAC, and an output voltage range from 5-48V. Measuring 41.00 x 100.00 x 92.00mm, the DIN rail is easy to install and remove for maintenance, while efficiently organizing all your electrical cables.

This series offers great operating temperatures, from -20°C to 70°C and also features an isolation of 3000VAC for improved reliability and system safety. Furthermore, a high MTBF of 2,001,900h, output over-load protection, output short circuit protection, and output over-voltage protection (OVP) come standard with the series.

The AMED60-GY is suitable for electric distribution boxes, grid power, instrumentation, CNC machines, industrial control panels and building automation applications.

Features

- Wide Input: 90 - 264VAC/127 – 370VDC
- Operating Temp: -20 °C to +70 °C
- Isolation voltage: 3000VAC
- Low ripple & noise, 80mV(p-p), 120mV(p-p), 150mV(p-p), and 200mV(p-p).
- Short circuit protection, over-voltage protection, and overload protection.
- DC OK Signal Output indication



Summary

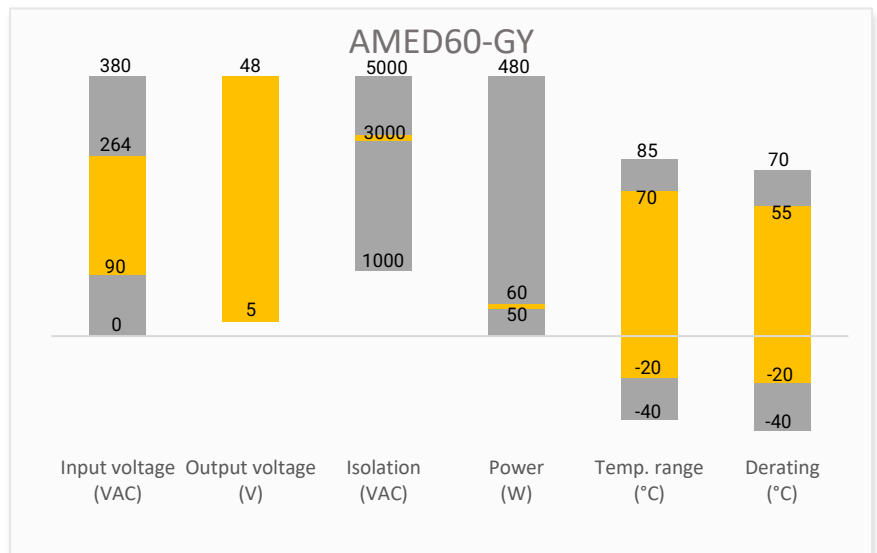

Training

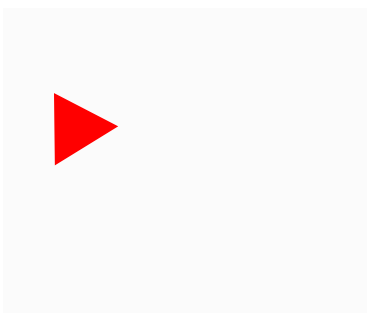

Product Training Video
(click to open)

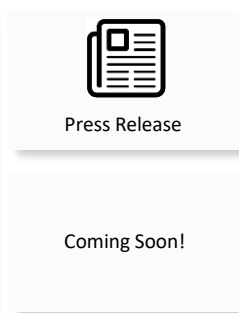

Application Notes

Applications



Power Grid



Industrial



Telecom

Models & Specifications



Model	Input Voltage (VAC/Hz)	Input Voltage (VDC)	Max Output wattage (W)	Output Voltage (V)	Output Current max (A)	Efficiency @ 230VAC Typ. (%)
AMED60-5SGY	90~264/47~63	127~370	50	5	10	78
AMED60-12SGY	90~264/47~63	127~370	60	12	5	86
AMED60-24SGY	90~264/47~63	127~370	60	24	2.5	88
AMED60-48SGY	90~264/47~63	127~370	60	48	1.25	78

Input Specifications

Parameters	Conditions	Typical	Maximum	Units
Input Current	115VAC	1.8		A
	230VAC	1.0		A
Inrush Current	230VAC, cold start	30	60	A
Leakage Current	240VAC	<1		mA

Output Specifications

Parameters	Conditions	Typical	Maximum	Units
Voltage accuracy	0 - 100% load	± 2		%
Line regulation	Rated load	± 2		%
Load regulation	0 - 100% load, 5, 12, 24, 48 VDC Output	± 5		%
Ripple & Noise*	5 VDC Output		80	mV p-p
	12 VDC Output		120	mV p-p
	24 VDC Output		150	mV p-p
	48 VDC Output		200	mV p-p
Start-up time	230VAC input, full load		0.5	s
	115VAC input, full load		0.5	s
Hold up time	230VAC input, full load	50		ms
	115VAC input, full load	20		ms
Rise time	230/115VAC input, full load	30		ms
Voltage adjustable range	5 VDC Output	5 – 6		V
	12 VDC Output	12 – 15		V
	24 VDC Output	24 – 30		V
	48 VDC Output	48 - 56		V

* Ripple and Noise are measured at 20MHz bandwidth. Please refer to the application note for specific details. Measured with a 47μF electrolytic capacitor and a 0.1μF ceramic capacitor.

Isolation Specifications

Parameters	Conditions	Typical	Maximum	Units
Tested I/O voltage	60 sec, Leakage current < 10mA	3000		VAC
Tested Input to GND voltage	60 sec, Leakage current < 10mA	2000		VAC
Tested Output to GND voltage	60 sec, Leakage current < 10mA	500		VAC
Tested Output to P-G signal	60 sec, Leakage current < 2mA	500		VAC
Insulation resistance	I to O, I/O to PE, 500VDC, 25°C, 70%RH	100		MΩ

General Specifications				
Parameters	Conditions	Typical	Maximum	Units
Over voltage protection	5 VDC Output, manual-recovery	≤ 7.25		VDC
	12 VDC Output, manual-recovery	≤ 18.0		VDC
	24 VDC Output, manual-recovery	≤ 36.0		VDC
	48 VDC Output, manual-recovery	≤ 64.8		VDC
Overload protection	105~150% rated output power, constant current limiting, auto-recovery			
Short circuit protection	Hiccup, Continuous, auto-recovery			
Operating temperature	20% ~ 90% RH Non-Condensing	-20 to +70		°C
Storage temperature	10 ~ 95% RH	-40 to +85		°C
Power derating	5 VDC Output, +45 °C to +70°C	2.0		% / °C
	12, 24, 48 VDC Output, +55 °C to +70°C	2.67		% / °C
	90VAC - 100VAC	2		% / VAC
Protection Class	Class I			
Cooling	Free air convection			
Storage Humidity	Non-condensing		10~95	% RH
Case material	Plastic			
Weight		280		g
Dimensions (L x W x H)	1.61 x 3.94 x 3.62 inches (41.00 x 100.00 x 92.00 mm)			
MTBF	> 2001.9k hrs min. Telcordia SR-332 (Bellcore)			
NOTE: All specifications in this datasheet are measured at an ambient temperature of 25°C, humidity<75%, nominal input voltage and at rated output load unless otherwise specified.				

Safety Specifications		
Parameters		
Agency approval	UL508, BS/EN62368-1	
Standards	EMC - Conducted and radiated emission	CISPR32 / EN55032, Class B
	Harmonic Current emission	IEC/EN 61000-3-2, Class A
	Voltage Fluctuations & Flicker	IEC/EN 61000-3-3
	Electrostatic Discharge Immunity	IEC/EN 61000-4-2 Contact ±4KV, Air ±8KV, Criteria B
	RF, Electromagnetic Field Immunity	IEC/EN 61000-4-3 3V/m, Criteria A
	Electrical Fast Transient/Burst Immunity	IEC/EN 61000-4-4 ±1KV, Criteria B
	Surge Immunity	IEC/EN 61000-4-5 L-L ±1KV, L-G ±2KV, Criteria B
	CS, Conducted Disturbance Immunity	IEC/EN 61000-4-6 3V, 3V~1V, 1V r.m.s, Criteria A
	Power Frequency Magnetic Field Immunity	IEC/EN 61000-4-8 50, 60Hz, Criteria A
	Voltage dips, Short Interruptions Immunity	IEC/EN 61000-4-11 100% Voltage Dips/Interruptions, 3 cycles, Criteria B

Derating

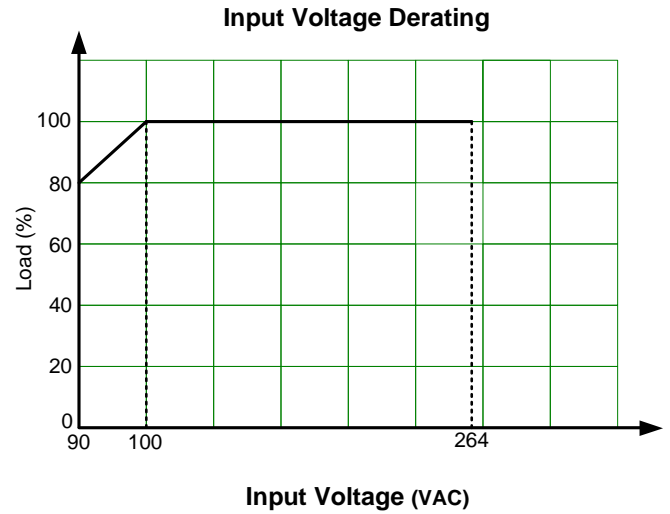
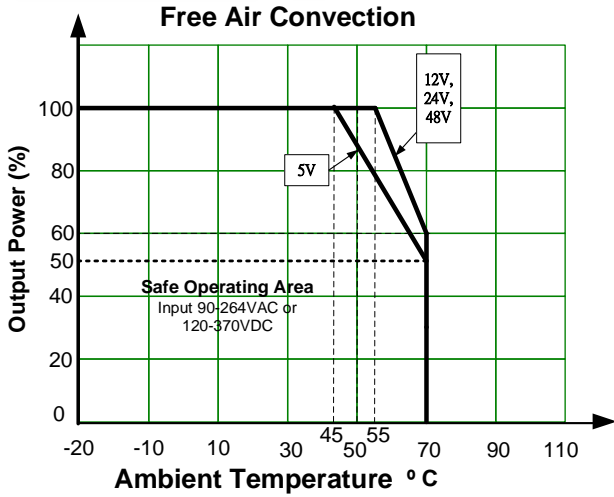

Functional Diagram

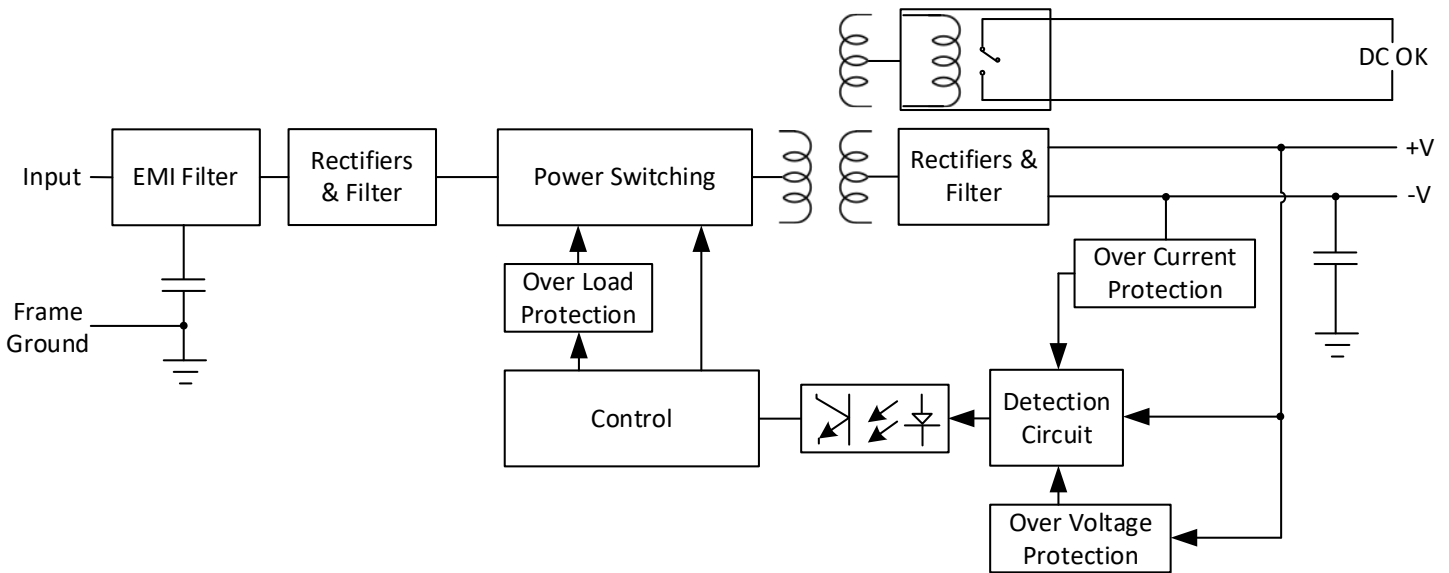

DC OK Active Signal Application

Contact Closed	Power Supply Unit turns on / DC OK
Contact Open	Power Supply Unit turns off / DC FAIL
Contact Ratings (maximum)	30 V / 1 A resistive load

Dimensions

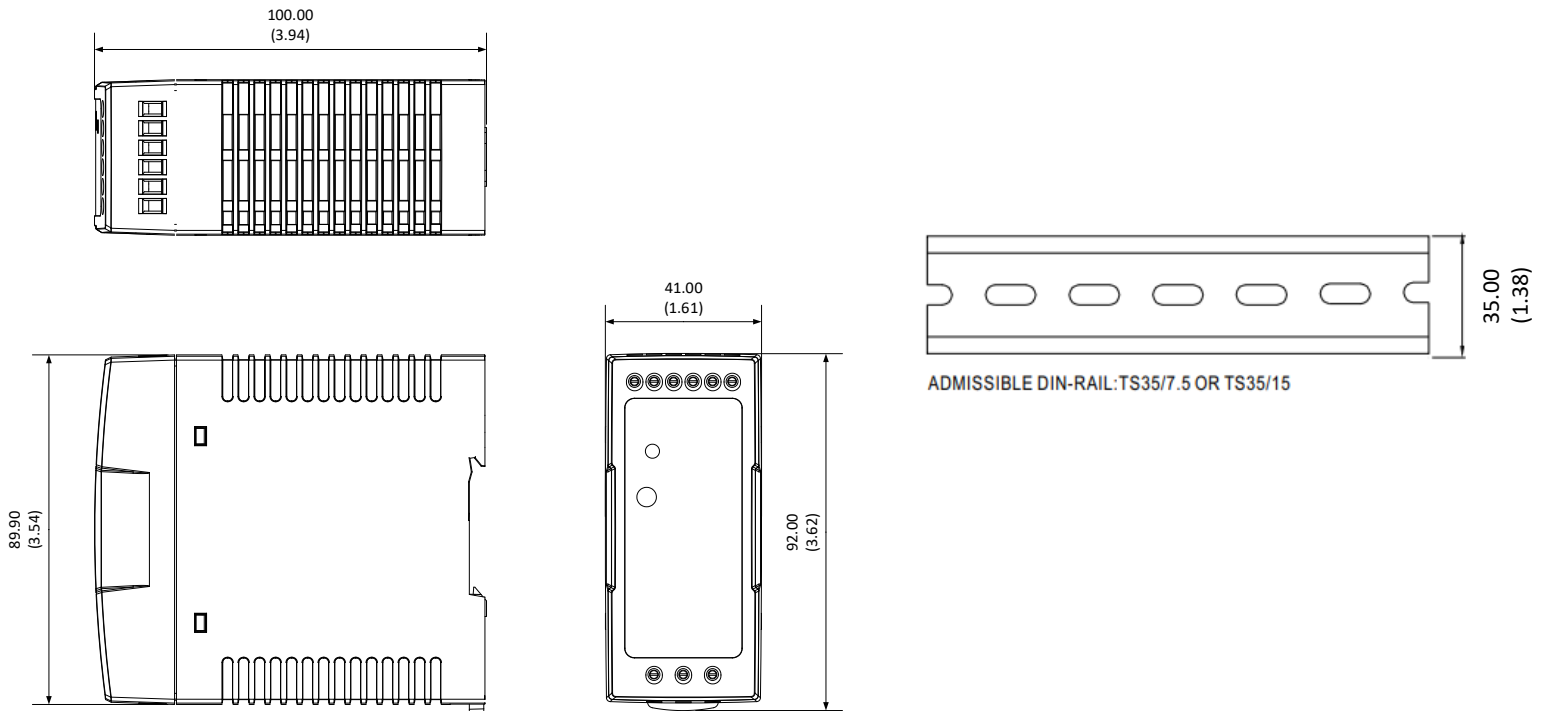

NOTE: 1. Datasheets are updated as needed and as such, specifications are subject to change without notice. Once printed or downloaded, datasheets are no longer controlled by Aimtec; refer to www.aimtec.com for the most current product specifications. **2.** Product labels shown, including safety agency certifications on labels, may vary based on the date manufactured. **3.** Mechanical drawings and specifications are for reference only. **4.** All specifications are measured at an ambient temperature of 25°C, humidity<75%, nominal input voltage and at rated output load unless otherwise specified. **5.** Aimtec may not have conducted destructive testing or chemical analysis on all internal components and chemicals at the time of publishing this document. CAS numbers and other limited information are considered proprietary and may not be available for release. **6.** This product is not designed for use in critical life support systems, equipment used in hazardous environments, nuclear control systems or other such applications which necessitate specific safety and regulatory standards other the ones listed in this datasheet. **7.** Warranty is in accordance with Aimtec's standard Terms of Sale available at www.aimtec.com.