

### SPECIFICATIONS

<b>CUSTOMER</b>	:	
<b>SAMPLE CODE</b>	:	SH102600T013-ZFC04
<b>MASS PRODUCTION CODE</b>	:	PH102600T013-ZFC04
<b>SAMPLE VERSION</b>	:	01
<b>SPECIFICATIONS EDITION</b>	:	003
<b>DRAWING NO. (Ver.)</b>	:	LMD-PH102600T013-ZFC04 (Ver.001)
<b>PACKAGING NO. (Ver.)</b>	:	PKG-PH102600T013-ZFC04 (Ver.001)

**Customer Approved**

---

**Date:**

Approved	Checked	Designer
廖志豪 <b>Rex Liao</b>	陳宗淇 <b>Howard Chen</b>	張慶源 <b>Yuan Chang</b>

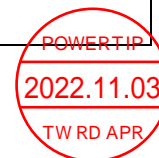

- Preliminary specification for design input
- Specification for sample approval

### POWER TIP TECH. CORP.

**Headquarters:**

No.8, 6<sup>th</sup> Road, Taichung Industrial Park,  
 Taichung, Taiwan  
 台中市 407 工業區六路 8 號

TEL: 886-4-2355-8168  
 FAX: 886-4-2355-8166

E-mail: [sales@powertip.com.tw](mailto:sales@powertip.com.tw)  
 Http://www.powertip.com.tw

## History of Version

Date (mm / dd / yyyy)	Ver.	Edi.	Description	Page	Design by
10/13/2021	01	001	New Drawing	-	Yuan
12/16/2021	01	002	First Sample	-	Yuan
11/02/2022	01	003	Modify Life Time from 20000hrs to 50000Hrs	9	Yuan

## Contents

### 1. SPECIFICATIONS

- 1.1 Features
- 1.2 Mechanical Specifications
- 1.3 Absolute Maximum Ratings
- 1.4 DC Electrical Characteristics
- 1.5 Optical Characteristics
- 1.6 Backlight Characteristics
- 1.7 Touch Panel Characteristics

### 2. MODULE STRUCTURE

- 2.1 Counter Drawing
- 2.2 Interface Pin Description
- 2.3 Timing Characteristics
- 2.4 AC Electrical Characteristics

### 3. QUALITY ASSURANCE SYSTEM

- 3.1 Quality Assurance Flow Chart
- 3.2 Inspection Specification

### 4. RELIABILITY TEST

- 4.1 Reliability Test Condition

### 5. PRECAUTION RELATING PRODUCT HANDLING

- 5.1 Safety
- 5.2 Handling
- 5.3 Storage
- 5.4 Terms of Warranty

#### Appendix :

- a. LCM Drawing
- b. LCM Packaging Specifications

## 1. SPECIFICATIONS

### 1.1 Features

Item	Standard Value
Display Type	1024 * 3 (RGB) * 600 Dots
LCD Type	Full Viewing Angle , Normally Black , Transmissive type
Screen size(inch)	7.0 inch
Color configuration	RGB-Strip
Backlight Type	LED B/L
Interface	LVDS Interface
Other(controller/driver IC)	ST5021-G3-1 + ST5651CB-G3-1 (Or Compatible IC)
ROHS	THIS PRODUCT CONFORMS THE ROHS OF PTC Detail information please refer website : <a href="http://www.powertip.com.tw/news_detail.php?Key=1&amp;cID=1">http://www.powertip.com.tw/news_detail.php?Key=1&amp;cID=1</a>

### 1.2 Mechanical Specifications

Item	Standard Value	Unit
Outline Dimension	192.96(W) * 121.4(L) * 4.7(H)	mm

#### LCD panel

Item	Standard Value	Unit
Viewing Area	155.01(W) x 86.92 (L)	mm
Active Area	154.214 (W) * 85.92 (L)	mm

Note : For detailed information please refer to LCM drawing

### 1.3 Absolute Maximum Ratings

#### Module

Item	Symbol	Condition	Min.	Max.	Unit
Power Voltage	V <sub>DD</sub>	-	-0.5	5	V
	AV <sub>DD</sub>	-	-0.5	15	V
	V <sub>GH</sub>	-	-0.3	40	V
	V <sub>GL</sub>	-	-20	0.3	V
Operating Temperature	T <sub>OP</sub> (T <sub>s</sub> )	Note 1	-20	70	°C
Storage Temperature	T <sub>ST</sub> (T <sub>a</sub> )	Note 2	-30	80	°C

The absolute maximum rating values of this product are not allowed to be exceeded at any times. Should a module be used with any of the absolute maximum ratings exceeded, the characteristics of the module may not be recovered, or in an extreme case, the module may be permanently destroyed.

Note 1 : T<sub>s</sub> is the temperature of panel's surface.

Note 2 : T<sub>a</sub> is the ambient temperature of samples.

### 1.4 DC Electrical Characteristics

#### Module

GND = 0V, T<sub>a</sub> = 25°C

Item	Symbol	Condition	Min.	Typ.	Max.	Unit	Remark
	V <sub>DD</sub>	-	2.5	3.3	3.6	V	
	AV <sub>DD</sub>	-	11.9	12.1	12.3	V	
	V <sub>GH</sub>	-	16.8	17.0	17.2	V	
	V <sub>GL</sub>	-	-7.2	-7.0	-6.8	V	
Input signal Voltage	V <sub>COM</sub>	-	4.0	4.2	4.4	V	
Input Signal Voltage	V <sub>IH</sub>	-	0.7DV <sub>DD</sub>	-	DV <sub>DD</sub>	V	
	V <sub>IL</sub>	-	0	-	0.3 DV <sub>DD</sub>	V	
Supply Current	I <sub>DD</sub>	DV <sub>DD</sub> = 3.3 V Pattern= Red	-	15	25	mA	Note1
	I <sub>ADD</sub>	AV <sub>DD</sub> =12.1V Pattern= Red	-	30	40	mA	
	I <sub>GH</sub>	V <sub>GH</sub> =17.0V Pattern= Red	-	0.5	1	mA	
	I <sub>GL</sub>	V <sub>GL</sub> =-7.0V Pattern= Red	-	0.5	1	mA	

Note1:Maximum current display

## 1.5 Optical Characteristics

### TFT LCD Module

VDD = 3.3 V, Ta=25°C

Item	Symbol	Condition	Min.	Typ.	Max.	unit		
Response time	Tr + Tf	Ta = 25°C θX, θY = 0°	-	32	48	ms	Note 2	
Viewing angle	Top	θY+	CR ≥ 10	-	80	-	Deg.	Note 4
	Bottom	θY-		-	80	-		
	Left	θX-		-	80	-		
	Right	θX+		-	80	-		
Contrast ratio	CR		650	800	-	-	Note 3	
Color of CIE Coordinate ( With B/L )	White	X	Ta = 25°C θX , θY = 0°	0.24	0.29	0.34	-	Note1
		Y		0.26	0.31	0.36		
	Red	X		0.54	0.59	0.64		
		Y		0.31	0.36	0.41		
	Green	X		0.27	0.32	0.37		
		Y		0.51	0.56	0.61		
	Blue	X		0.08	0.13	0.18		
		Y		0.03	0.08	0.13		
Average Brightness Pattern=white display (With LCD & CTP)*1	IV	IF=200 mA	365	435	-	cd/m <sup>2</sup>	Note1	
Uniformity (With LCD& CTP)*2	△B	IF=200 mA	70	-	-	%	Note1	

Note 1:

\*1 :  $\Delta B = B(\min) / B(\max) * 100\%$

\*2 : Measurement Condition for Optical Characteristics:

a : Environment:  $25^{\circ}\text{C} \pm 5^{\circ}\text{C}$  /  $60 \pm 20\%$  R.H , no wind , dark room below 10 Lux at typical lamp current and typical operating frequency.

b : Measurement Distance:  $500 \pm 50$  mm , ( $\theta = 0^{\circ}$ )

c : Equipment: TOPCON BM-7 fast , (field  $1^{\circ}$ ) , after 10 minutes operation.

d : The uncertainty of the C.I.E coordinate measurement  $\pm 0.01$  , Average Brightness  $\pm 4\%$

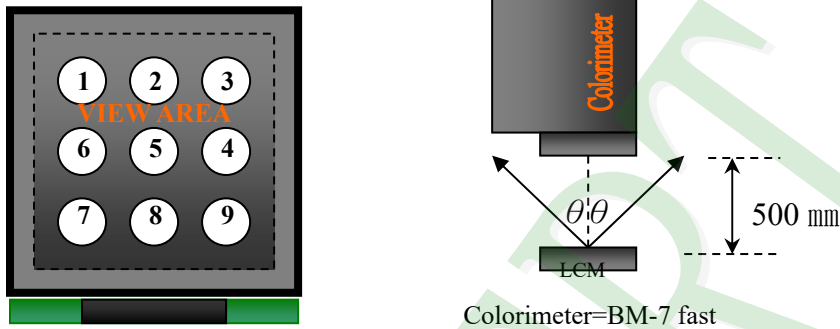

To be measured at the center area of panel with a viewing cone of  $1^{\circ}$  by Topcon luminance meter BM-7, after 10 minutes operation (module)

Note2: Definition of response time:

The output signals of photo detector are measured when the input signals are changed from "black" to "white"(falling time) and from "white" to "black"(rising time), respectively. The response time is defined as the time interval between the 10% and 90% of Amplitudes.

Refer to figure as below:

Normally White



### Normally Black

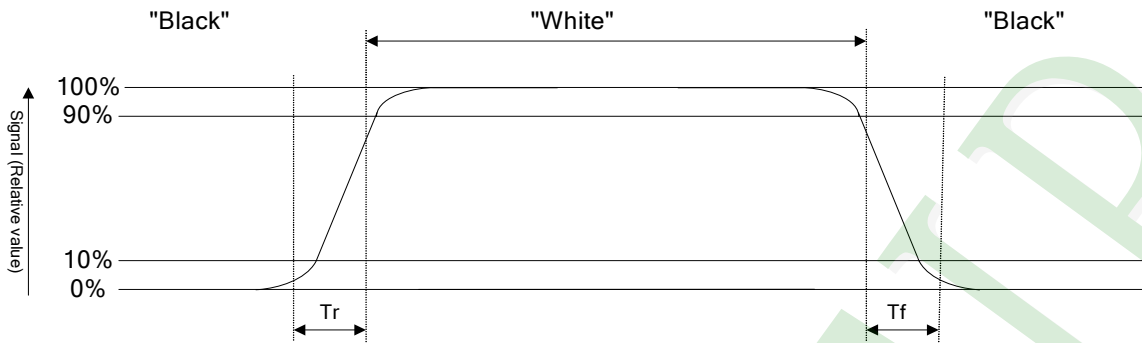

Note3: Definition of contrast ratio:

Contrast ratio is calculated with the following formula

$$\text{Contrast ratio (CR)} = \frac{\text{Photo detector output when LCD is at "White" state}}{\text{Photo detector output when LCD is at "Black" state}}$$

Note4: Definition of viewing angle:

Refer to figure as below:

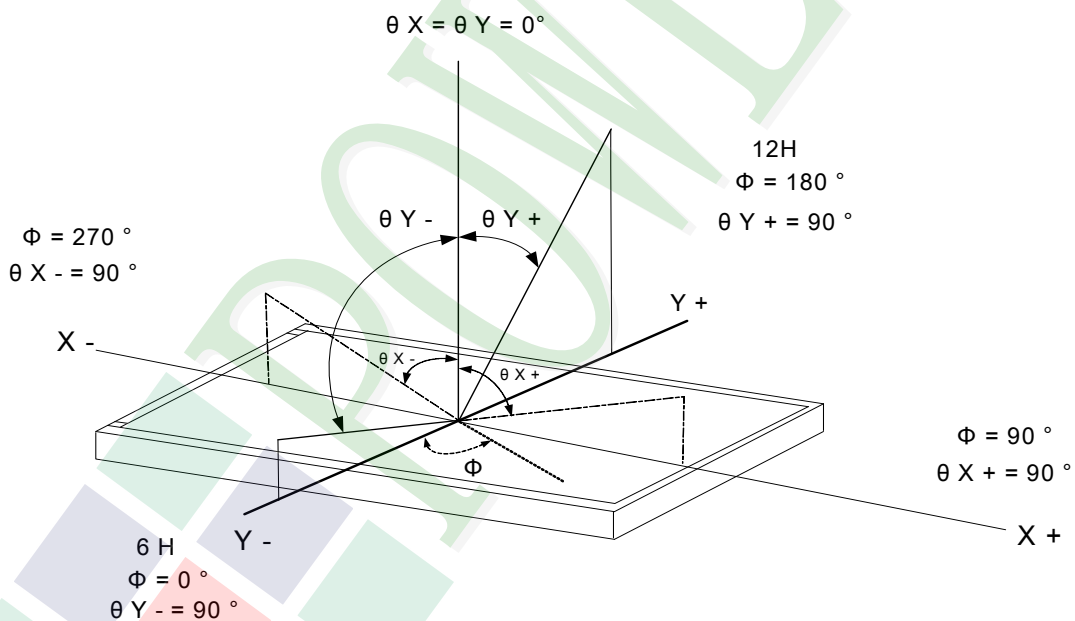

Note5: Applying with spectrophotometer in the condition of 400 to 700nm, 10nm/each; in accordance with JIS Z 8701 2 degree viewing XYZ system, measuring the reflective rate of 5 degree



## 1.6 Backlight Characteristics

### Maximum Ratings

Item	Symbol	Conditions	Min.	Max.	Unit
LED Forward Current	IF	Ta =25°C	-	300	mA
LED Reverse Voltage	VR	Ta =25°C	-	5	V
Power Dissipation	PD	Ta =25°C	-	3.06	W

### Backlight Characteristics

Item	Symbol	Conditions	Min.	Typ.	Max.	Unit
Forward Voltage	VF	IF=200mA	8.4	9.0	10.2	V
Average Brightness (Without LCD )	IV		10000	12000	14000	cd/m <sup>2</sup>
CIE Color Coordinate (Without LCD )	X		0.24	0.27	0.30	-
	Y		0.22	0.25	0.28	
Uniformity *1	△B		80	-	-	*2
Color		White				

\*1 : This value will be changed while mass production.

\*2 :  $\Delta B = B(\min) / B(\max)\%$

B/L Internal Circuit Diagram

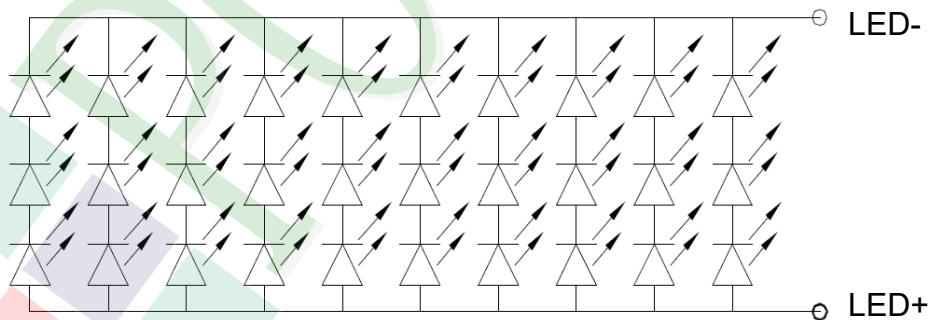

### Other Description

Item	Conditions	Description
Life Time	Ta =25°C IF=200mA	50000 hrs

## 1.7 Touch Panel Characteristics

### Features

Item	Standard Value
Touch Panel Size	7.0"
Touch type	True Multi-Touch Capacitive Touch Panel
Input Method	True Multi-touch with up to 5 Points of Absolution X and Y Coordinates
Output Interface	I <sup>2</sup> C
IC	ICNT8952

### I<sup>2</sup>C Address

Bit 7	Bit 6	Bit 5	Bit 4	Bit 3	Bit 2	Bit 1	Bit 0
1	0	0	1	0	0	0	R/W

Bit 0: 0 for Write / 1 for Read

### Absolute Maximum Ratings

Item	Symbol	Condition	Min.	Max.	Unit
Supply voltage	TPVDD	-	-0.3	3.6	V
Operating Temperature	T <sub>OP</sub>	Non condensing	-20	70	°C
Storage Temperature	T <sub>ST</sub>	Non condensing	-30	80	°C

### DC Electrical Characteristics

Item	Symbol	Condition	Min.	Typ.	Max.	Unit
Supply voltage	TPVDD	25°C	-	3.3	-	V
Input high-level voltage	V <sub>IH</sub>	--	0.7 x TPVDD	-	TPVDD	V
Input low -level voltage	V <sub>IL</sub>	--	-0.3	-	0.3 x TPVDD	V
Output high -level voltage	V <sub>OH</sub>	--	0.7 x TPVDD	-	-	V
Output low -level voltage	V <sub>OL</sub>	--	-	-	0.3 x TPVDD	V

### Optical Characteristics

Item	Standard Value	Unit
Total light transmittance	87% or more	-
Hardness	≥6H	-

Note: Not Support Gesture Function

## 2. MODULE STRUCTURE

### 2.1 Counter Drawing

#### 2.1.1 LCM Mechanical Diagram

\* See Appendix

#### 2.1.2 Block Diagram

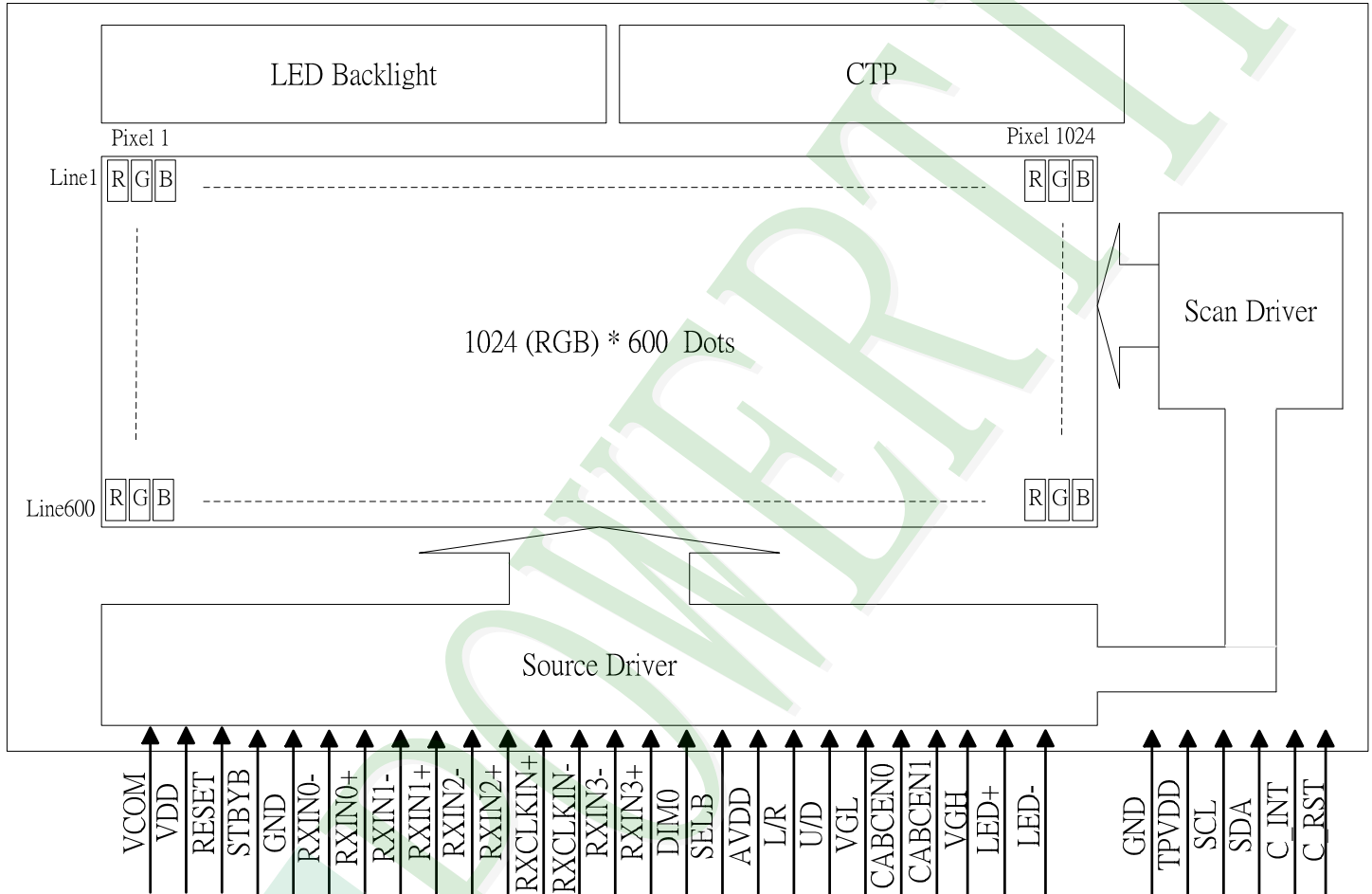

## 2.2 Interface Pin Description

Pin No.	Symbol	Function
1	VCOM	Common Voltage
2	VDD	Power Voltage for digital circuit
3	VDD	Power Voltage for digital circuit
4	NC	No connection
5	Reset	Global reset pin
6	STBYB	Standby mode, Normally pulled high STBYB = "1" , normal operation STBYB = "0" , timing controller, source driver will turn off, all output are High-Z
7	GND	Ground
8	RXIN0-	- LVDS differential data input
9	RXIN0+	+ LVDS differential data input
10	GND	Ground
11	RXIN1-	- LVDS differential data input
12	RXIN1+	+ LVDS differential data input
13	GND	Ground
14	RXIN2-	- LVDS differential data input
15	RXIN2+	+ LVDS differential data input
16	GND	Ground
17	RXCLKIN-	- LVDS differential clock input
18	RXCLKIN+	+ LVDS differential clock input
19	GND	Ground
20	RXIN3-	- LVDS differential data input
21	RXIN3+	+ LVDS differential data input
22	GND	Ground
23	NC	No Connection
24	NC	No Connection
25	GND	Ground

Pin No.	Symbol	Function
26	NC	No Connection
27	DIM0	Backlight CABC controller signal output DIM0=L Turn off external backlight controller DIM0=H Logical control signal to turn on external backlight controller
28	SELB	6bit/8bit mode select If LVDS input data is 6 bits ,SELB must be set to High; If LVDS input data is 8 bits ,SELB must be set to Low.
29	AVDD	Power for Analog Circuit
30	GND	Ground
31	LED-	LED Cathode
32	LED-	LED Cathode
33	L/R	Horizontal inversion When L/R="0", set right to left scan direction. When L/R="1", set left to right scan direction.
34	U/D	Vertical inversion When U/D="0", set top to bottom scan direction. When U/D="1", set bottom to top scan direction.
35	VGL	Gate OFF Voltage
36	CABCEN1	CABC H/W enable Note:1
37	CABCEN0	CABC H/W enable Note:1
38	VGH	Gate ON Voltage
39	LED+	LED Anode
40	LED+	LED Anode

Note1:

CABCEN1	CABCEN0	DESCRIPTION
L	L	CABC OFF
L	H	User interface Image
H	L	Still Picture
H	H	Moving Image

## Capacitive Touch Panel (CTP) Interface

Pin No.	Symbol	Function
1	GND	Ground.
2	TPVDD	Power.
3	SCL	I <sup>2</sup> C Clock.
4	SDA	I <sup>2</sup> C Data.
5	C_INT	The interrupt from the CTP to the Host H: CTP interrupt not requested L: CTP request interrupt
6	C_RST	RESET.

## 2.3 Timing Characteristics

### DE mode

Parameter	Symbol	Value			Unit
		Min.	Typ.	Max.	
CLKIN frequency@ Frame rate = 60Hz	fclk	40.8	51.2	67.2	MHz
Horizontal display area	thd	1024			CLKIN
1 Horizontal Line	th	1114	1344	1400	
HSD Blanking	thb+thfp	90	320	376	
Vertical display area	tvd	600			H
1 vertical Line	tv	610	635	800	
VSD Blanking	tvb+tvfp	10	35	200	

### SYNC mode

#### Horizontal input timing

Parameter	Symbol	Value			Unit
		Min.	Typ.	Max.	
CLKIN frequency@ Frame rate = 60Hz	fclk	44.9	51.2	63	MHz
Horizontal display area	thd	1024			CLKIN
1 Horizontal Line	th	1200	1344	1400	
HSD pulse width	thpw	1	-	140	
HSD Blanking	thb	160			
HSD Front Porch	thfp	16	160	216	

#### Vertical input timing

Parameter	Symbol	Value			Unit
		Min.	Typ.	Max.	
Vertical display area	tvd	600			H
VSD period time	tv	624	635	750	
VSD pulse width	tvpw	1	-	20	
VSD Blanking	tvb	23			
VSD Front Porch	tvfp	1	12	127	

## Data Input Format For LVDS

### 6 bit LVDS input

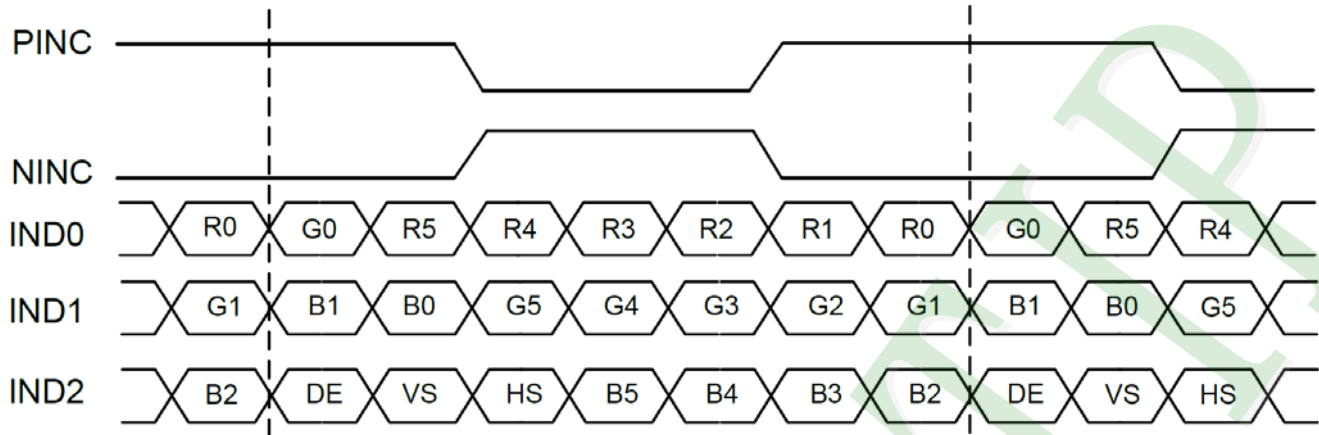

### 8 bit LVDS input

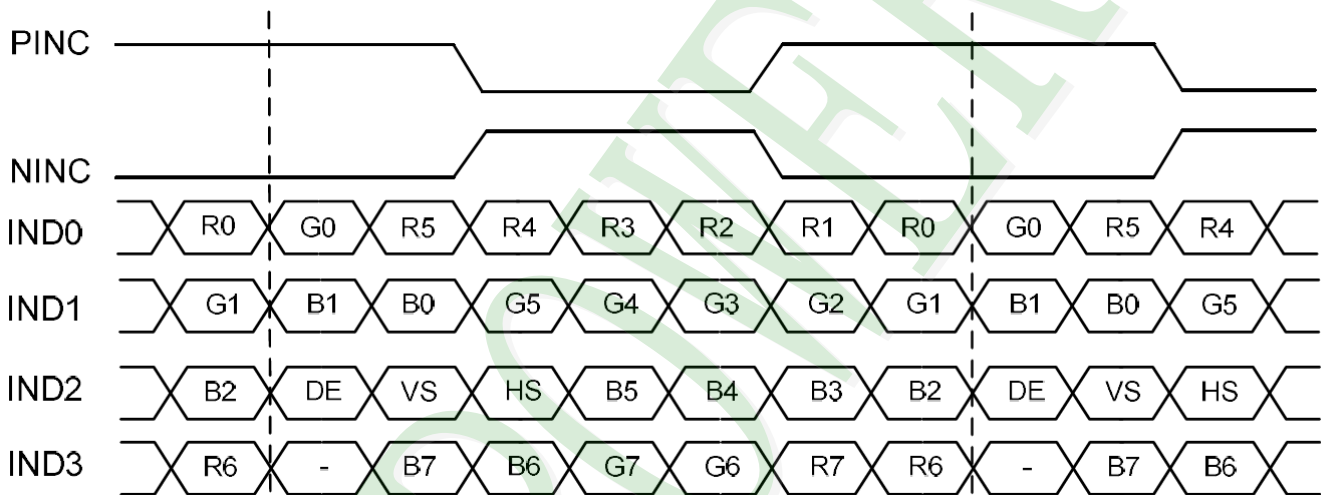



## SDRRS (Seamless Display Refresh Rate Switching) Timing Diagram

When showing the still picture, it is acceptable to reduce the refresh rate from 60Hz to low refresh rate (For example 40Hz). The purpose is mainly for power saving. INTEL defined a timing chart switch between different refresh rates. Following this timing chart, the switch between different refresh rates is seamless for end user.

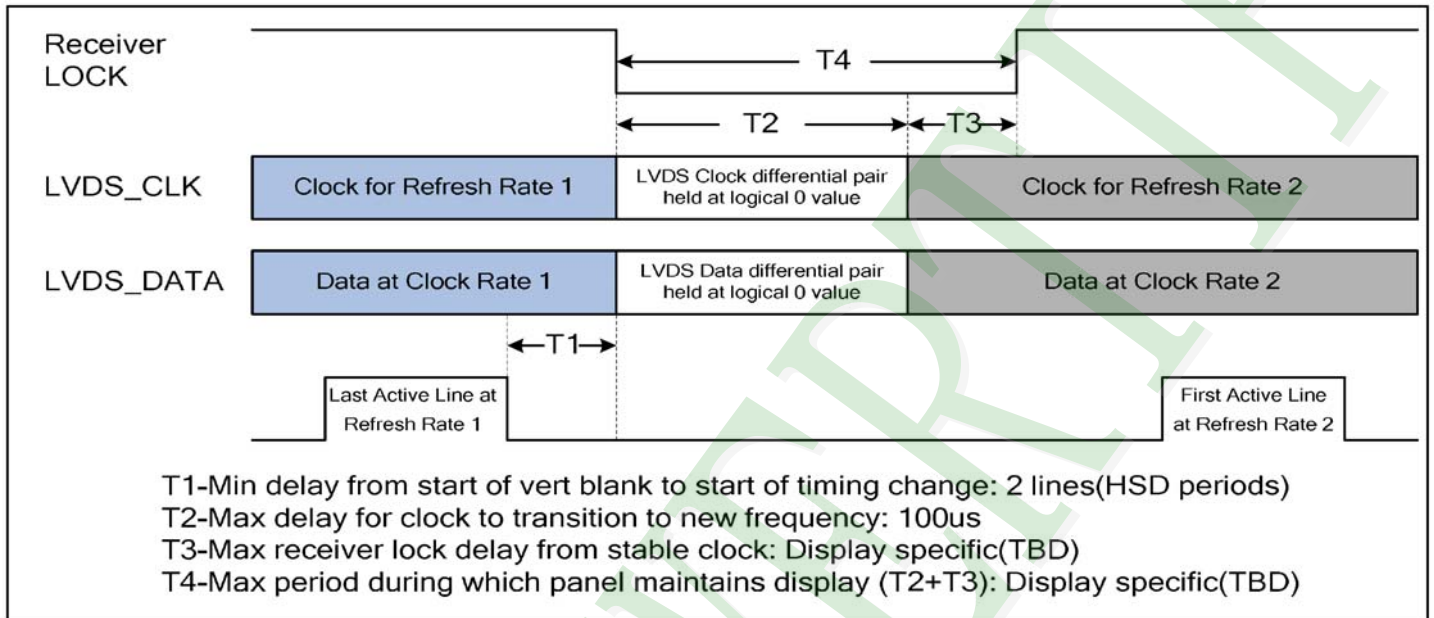

## 2.4 Power Sequence

### 2.4.1 Power On/Off Sequence

In order to prevent IC from power on reset fail, the rising time (TPOR) of the digital power supply VDD should be maintained within the given specifications. Refer to “AC Characteristics” for more detail on timing.

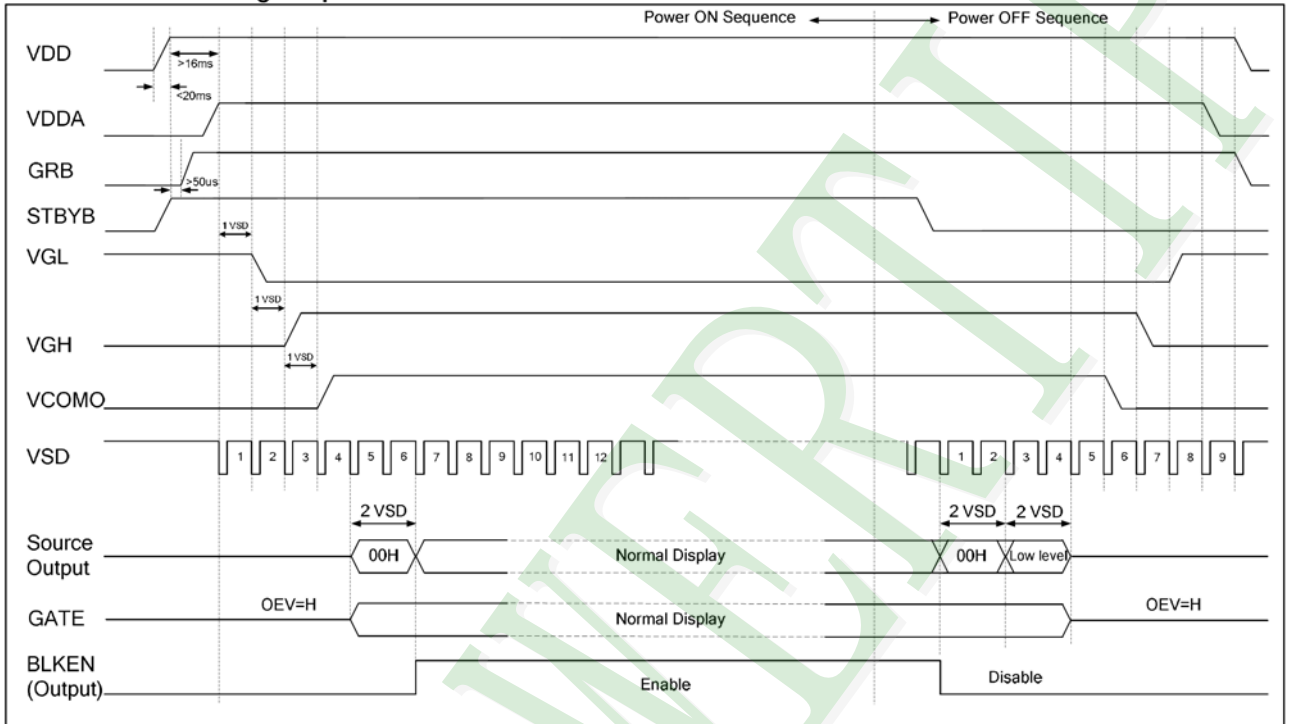

### 2.4.2 Standby mode Sequence

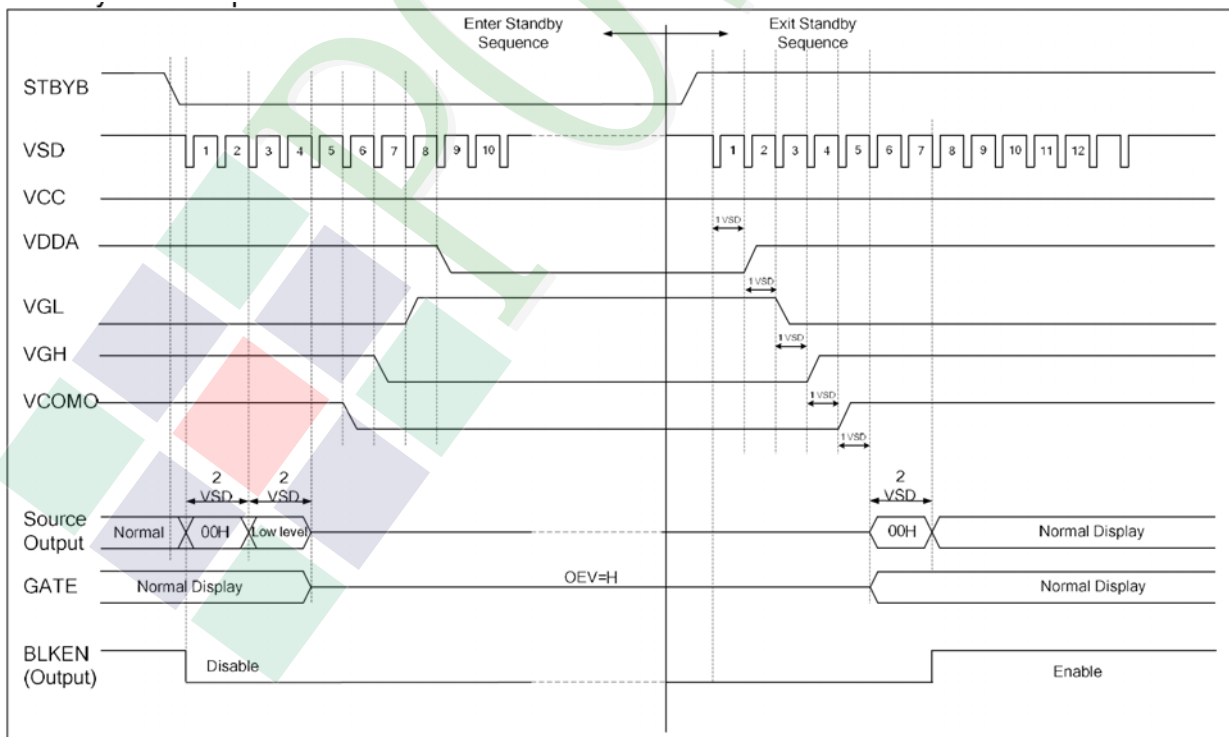

### 3. QUALITY ASSURANCE SYSTEM

#### 3.1 Quality Assurance Flow Chart

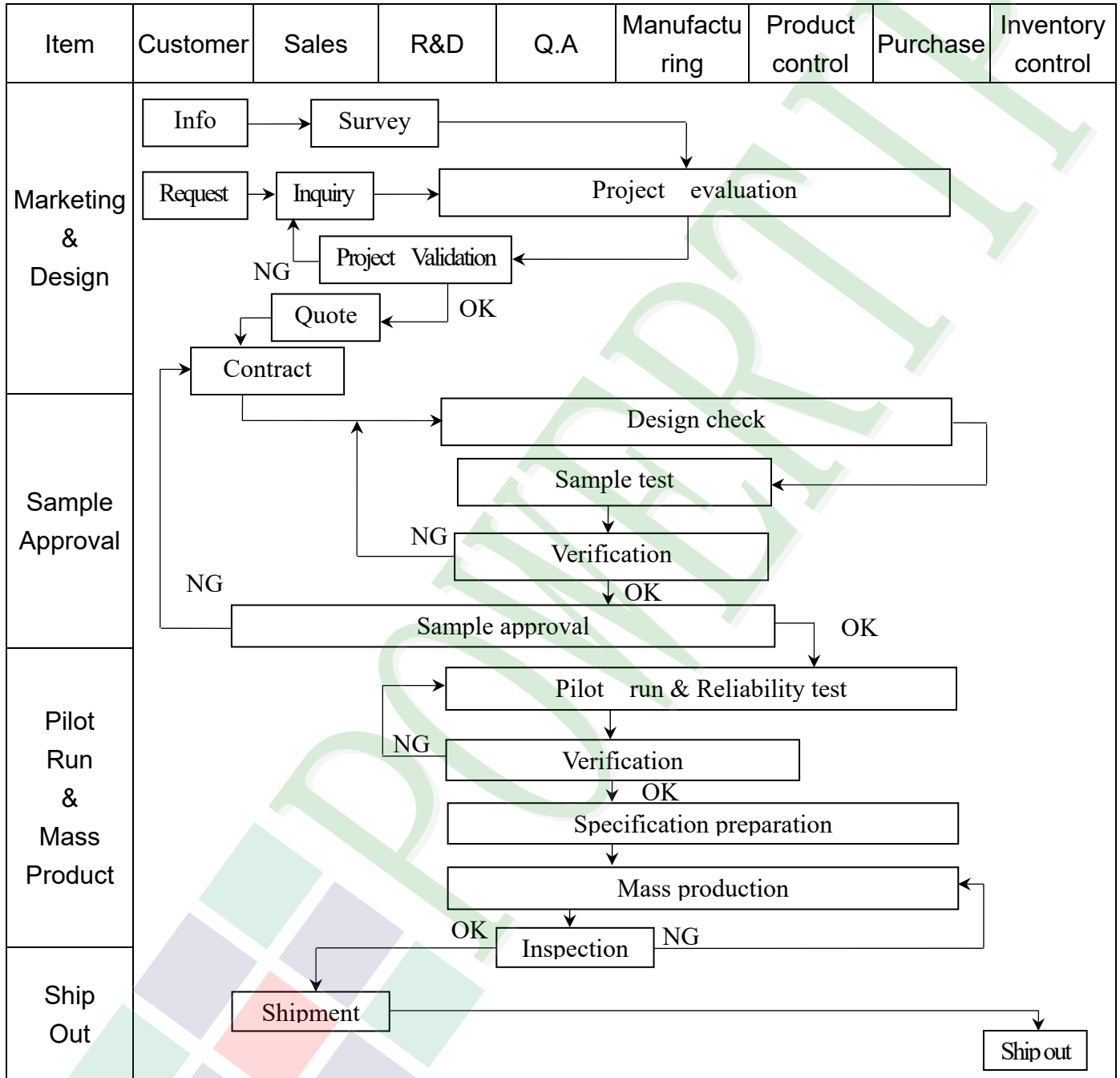

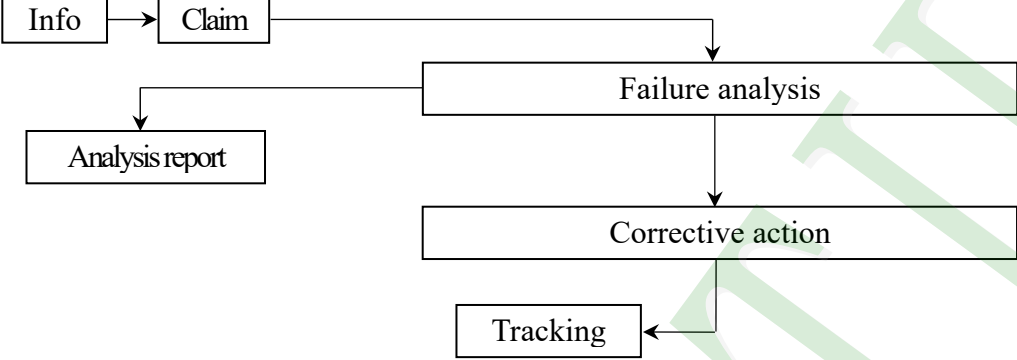
Item	Customer	Sales	R&D	Q.A	Manufacturing	Product control	Purchase	Inventory control
Sales Service	 <pre> graph TD     Info[Info] --&gt; Claim[Claim]     Claim --&gt; Failure[Failure analysis]     Failure --&gt; Report[Analysis report]     Failure --&gt; Action[Corrective action]     Action --&gt; Tracking[Tracking]           </pre>							
Q.A Activity	1. ISO 9001 Maintenance Activities 3. Equipment calibration 5. Standardization Management				2. Process improvement proposal 4. Education And Training Activities			

### 3.2. Inspection Specification

- ◆Scope: The document shall be applied to TFT-LCD Module for 3.5" -15" (Ver.B01).
- ◆Inspection Standard: MIL-STD-105E Table Normal Inspection Single Sampling Level II.
- ◆Equipment: Gauge, MIL-STD, Powertip Tester, Sample
- ◆Defect Level: Major Defect AQL: 0. 4; Minor Defect AQL: 1. 5
- ◆OUT Going Defect Level: Sampling.
- ◆Standard of the product appearance test:

a. Manner of appearance test:

- (1). The test best be under 20W×2 fluorescent light(about 300lux ~500lux)  
 , and distance of view must be at 30~40 cm.
- (2). The test direction is base on about around 45° of vertical line.

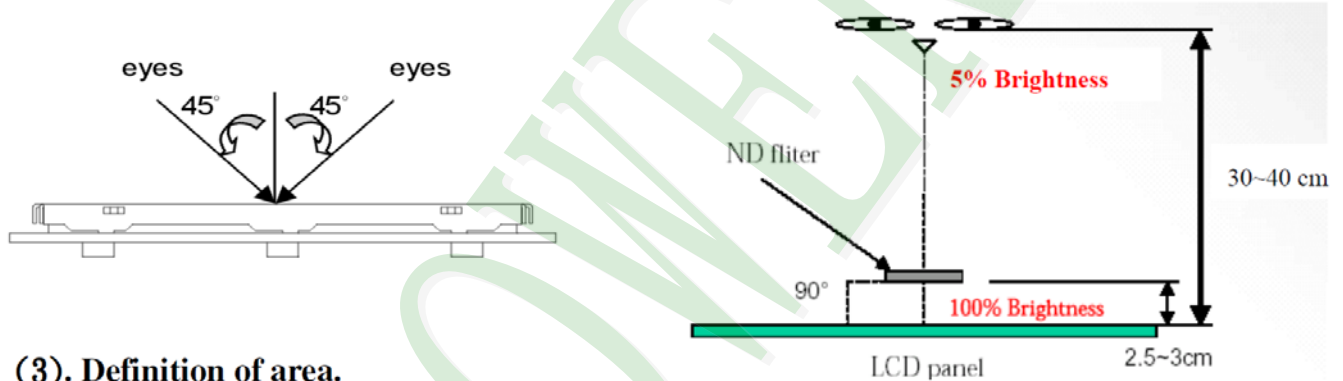

(3). Definition of area.

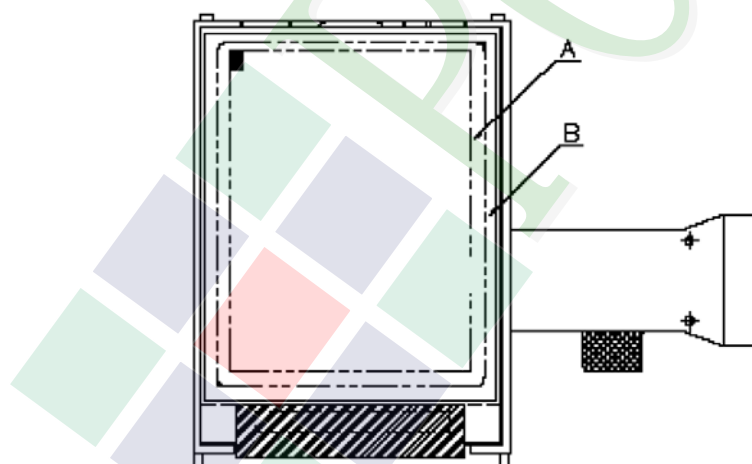

A area: viewing area

B area: Outside of viewing area

(4). Standard of inspection : (Unit : mm)

**◆Specification For TFT-LCD Module 3.5" ~15" :**

(Ver.B01)

NO	Item	Criterion	Level										
01	Product condition	1. 1The part number is inconsistent with work order of production.	Major										
		1. 2 Mixed product types.	Major										
		1. 3 Assembled in inverse direction.	Major										
02	Quantity	2. 1The quantity is inconsistent with work order of production.	Major										
03	Outline dimension	3. 1Product dimension and structure must conform to structure diagram.	Major										
04	Electrical Testing	4. 1 Missing line character and icon.	Major										
		4. 2 No function or no display.	Major										
		4. 3 Display malfunction.	Major										
		4. 4 LCD viewing angle defect.	Major										
		4. 5 Current consumption exceeds product specifications.	Major										
		4. 6Mura cannot be seen through 5% ND filter at 50% Gray , should be judged by the viewing angle of 90 degree.	Minor										
05	Dot defect (Bright dot, Dark dot)  On -display	<table border="1"> <thead> <tr> <th>Item</th> <th>Acceptance (Q'ty)</th> </tr> </thead> <tbody> <tr> <td>Bright Dot</td> <td>≤ 4</td> </tr> <tr> <td>Dark Dot</td> <td>≤ 5</td> </tr> <tr> <td>Joint Dot</td> <td>≤ 3</td> </tr> <tr> <td>Total</td> <td>≤ 7</td> </tr> </tbody> </table>	Item	Acceptance (Q'ty)	Bright Dot	≤ 4	Dark Dot	≤ 5	Joint Dot	≤ 3	Total	≤ 7	Minor
		Item	Acceptance (Q'ty)										
Bright Dot	≤ 4												
Dark Dot	≤ 5												
Joint Dot	≤ 3												
Total	≤ 7												
5. 1 Inspection pattern: full white, full black, Red, Green and blue screens. 5. 2 It is defined as dot defect if defect area > 1/2 dot. 5. 3 The distance between two dot defect ≥ 5 mm. 5. 4 Bright dot that can not be seen through 5% ND filter.													

**◆ Specification For TFT-LCD Module 3.5" ~15" :**

(Ver.B01)

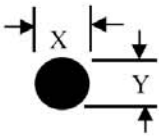
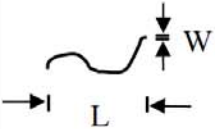
NO	Item	Criterion	Level																																																													
06	Black or white Dot, scratch, contamination  Round type    $\Phi = (x + y) / 2$  Line type  	<b>6. 1 Round type (Non-display or display):</b>  <table border="1"> <thead> <tr> <th rowspan="2">Dimension (diameter : <math>\Phi</math>)</th> <th colspan="2">Acceptance (Q'ty)</th> </tr> <tr> <th>A area</th> <th>B area</th> </tr> </thead> <tbody> <tr> <td><math>\Phi \leq 0.25</math></td> <td colspan="2">Ignore</td> </tr> <tr> <td><math>0.25 &lt; \Phi \leq 0.50</math></td> <td>5</td> <td rowspan="3">Ignore</td> </tr> <tr> <td><math>\Phi &gt; 0.50</math></td> <td>0</td> </tr> <tr> <td><b>Total</b></td> <td>5</td> </tr> </tbody> </table>  <b>6. 2 Line type(Non-display or display):</b>  <table border="1"> <thead> <tr> <th rowspan="2">module size</th> <th rowspan="2">Length (L)</th> <th rowspan="2">Width (W)</th> <th colspan="2">Acceptance (Q'ty)</th> </tr> <tr> <th>A area</th> <th>B area</th> </tr> </thead> <tbody> <tr> <td rowspan="5">3.5" to less 9"</td> <td>---</td> <td><math>W \leq 0.03</math></td> <td colspan="2">Ignore</td> </tr> <tr> <td><math>L \leq 10.0</math></td> <td><math>0.03 &lt; W \leq 0.05</math></td> <td>4</td> <td rowspan="3">Ignore</td> </tr> <tr> <td><math>L \leq 5.0</math></td> <td><math>0.05 &lt; W \leq 0.10</math></td> <td>2</td> </tr> <tr> <td>---</td> <td><math>W &gt; 0.10</math></td> <td colspan="2">As round type</td> </tr> <tr> <td colspan="3">Total</td> <td colspan="2">5</td> </tr> <tr> <td rowspan="4">9" to 15"</td> <td>---</td> <td><math>W \leq 0.05</math></td> <td colspan="2">Ignore</td> </tr> <tr> <td><math>L \leq 10.0</math></td> <td><math>0.05 &lt; W \leq 0.10</math></td> <td>5</td> <td rowspan="3">Ignore</td> </tr> <tr> <td>---</td> <td><math>W &gt; 0.10</math></td> <td colspan="2">As round type</td> </tr> <tr> <td colspan="3">Total</td> <td colspan="2">5</td> </tr> </tbody> </table>	Dimension (diameter : $\Phi$ )	Acceptance (Q'ty)		A area	B area	$\Phi \leq 0.25$	Ignore		$0.25 < \Phi \leq 0.50$	5	Ignore	$\Phi > 0.50$	0	<b>Total</b>	5	module size	Length (L)	Width (W)	Acceptance (Q'ty)		A area	B area	3.5" to less 9"	---	$W \leq 0.03$	Ignore		$L \leq 10.0$	$0.03 < W \leq 0.05$	4	Ignore	$L \leq 5.0$	$0.05 < W \leq 0.10$	2	---	$W > 0.10$	As round type		Total			5		9" to 15"	---	$W \leq 0.05$	Ignore		$L \leq 10.0$	$0.05 < W \leq 0.10$	5	Ignore	---	$W > 0.10$	As round type		Total			5		Minor
Dimension (diameter : $\Phi$ )	Acceptance (Q'ty)																																																															
	A area	B area																																																														
$\Phi \leq 0.25$	Ignore																																																															
$0.25 < \Phi \leq 0.50$	5	Ignore																																																														
$\Phi > 0.50$	0																																																															
<b>Total</b>	5																																																															
module size	Length (L)	Width (W)	Acceptance (Q'ty)																																																													
			A area	B area																																																												
3.5" to less 9"	---	$W \leq 0.03$	Ignore																																																													
	$L \leq 10.0$	$0.03 < W \leq 0.05$	4	Ignore																																																												
	$L \leq 5.0$	$0.05 < W \leq 0.10$	2																																																													
	---	$W > 0.10$	As round type																																																													
	Total			5																																																												
9" to 15"	---	$W \leq 0.05$	Ignore																																																													
	$L \leq 10.0$	$0.05 < W \leq 0.10$	5	Ignore																																																												
	---	$W > 0.10$	As round type																																																													
	Total				5																																																											
07	Polarizer Bubble	<table border="1"> <thead> <tr> <th rowspan="2">Dimension (diameter: <math>\Phi</math>)</th> <th colspan="2">Acceptance (Q'ty)</th> </tr> <tr> <th>A area</th> <th>B area</th> </tr> </thead> <tbody> <tr> <td><math>\Phi \leq 0.25</math></td> <td colspan="2">Ignore</td> </tr> <tr> <td><math>0.25 &lt; \Phi \leq 0.50</math></td> <td>4</td> <td rowspan="3">Ignore</td> </tr> <tr> <td><math>0.50 &lt; \Phi \leq 0.80</math></td> <td>1</td> </tr> <tr> <td><math>\Phi &gt; 0.80</math></td> <td>0</td> </tr> <tr> <td><b>Total</b></td> <td colspan="2">5</td> </tr> </tbody> </table>	Dimension (diameter: $\Phi$ )	Acceptance (Q'ty)		A area	B area	$\Phi \leq 0.25$	Ignore		$0.25 < \Phi \leq 0.50$	4	Ignore	$0.50 < \Phi \leq 0.80$	1	$\Phi > 0.80$	0	<b>Total</b>	5		Minor																																											
Dimension (diameter: $\Phi$ )	Acceptance (Q'ty)																																																															
	A area	B area																																																														
$\Phi \leq 0.25$	Ignore																																																															
$0.25 < \Phi \leq 0.50$	4	Ignore																																																														
$0.50 < \Phi \leq 0.80$	1																																																															
$\Phi > 0.80$	0																																																															
<b>Total</b>	5																																																															

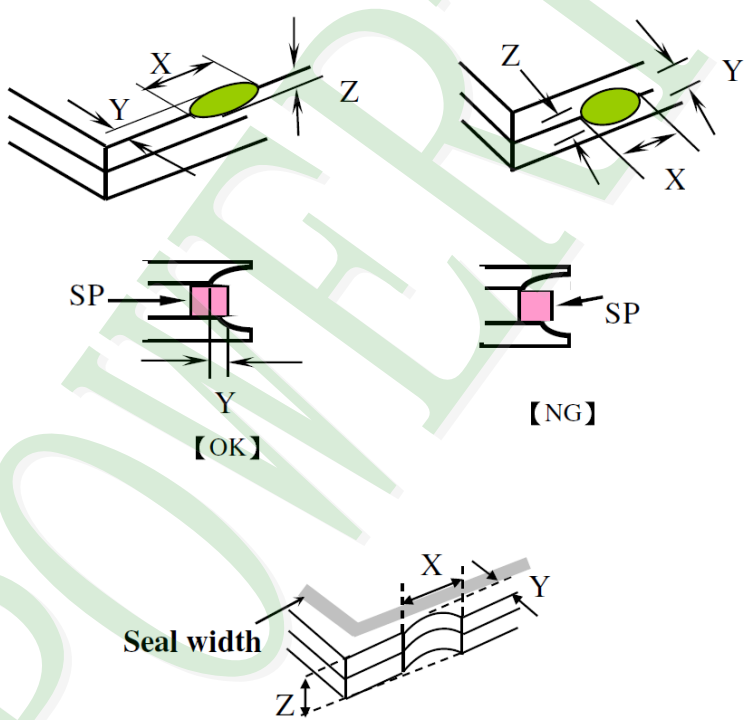

NO	Item	Criterion	Level						
08	The crack of glass	<p><b>Symbols :</b></p> <p><b>X:</b> The length of crack  <b>Z:</b> The thickness of crack  <b>t:</b> The thickness of glass</p> <p><b>Y:</b> The width of crack.  <b>W:</b> terminal length  <b>a:</b> LCD side length</p>	Minor						
		<p><b>8.1 General glass chip:</b></p> <p><b>8.1.1 Chip on panel surface and crack between panels:</b></p>  <table border="1" data-bbox="542 1523 1324 1814"> <thead> <tr> <th>X</th> <th>Y</th> <th>Z</th> </tr> </thead> <tbody> <tr> <td><math>\leq a</math></td> <td>Crack can't enter viewing area</td> <td><math>\leq 1/2 t</math></td> </tr> <tr> <td><math>\leq a</math></td> <td>Crack can't exceed the half of SP width.</td> <td><math>1/2 t &lt; Z \leq 2 t</math></td> </tr> </tbody> </table>		X	Y	Z	$\leq a$	Crack can't enter viewing area	$\leq 1/2 t$
X	Y	Z							
$\leq a$	Crack can't enter viewing area	$\leq 1/2 t$							
$\leq a$	Crack can't exceed the half of SP width.	$1/2 t < Z \leq 2 t$							

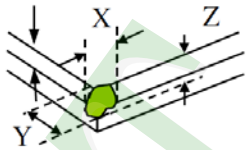
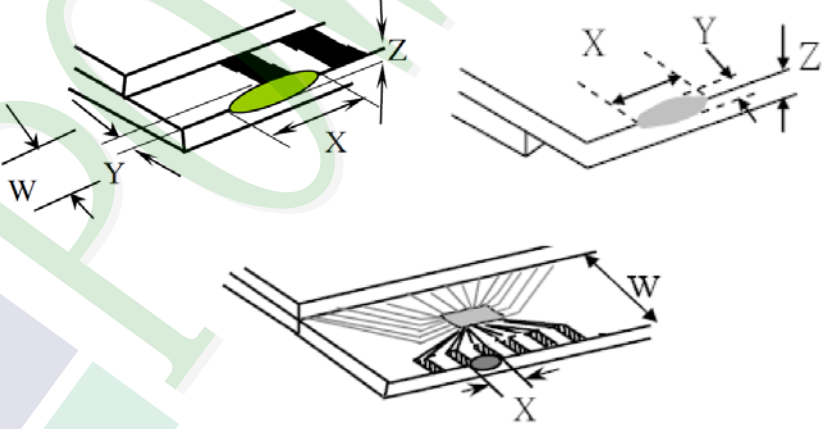

**◆ Specification For TFT-LCD Module 3.5" ~15" :**

(Ver.B01)

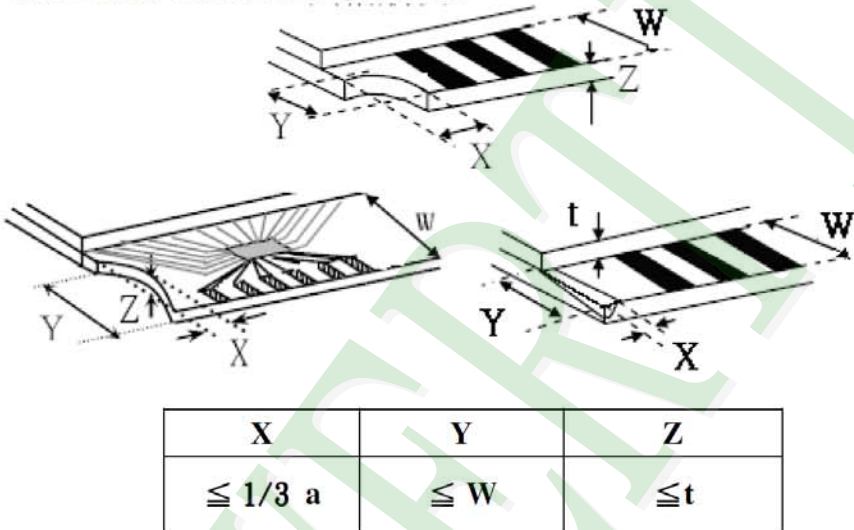
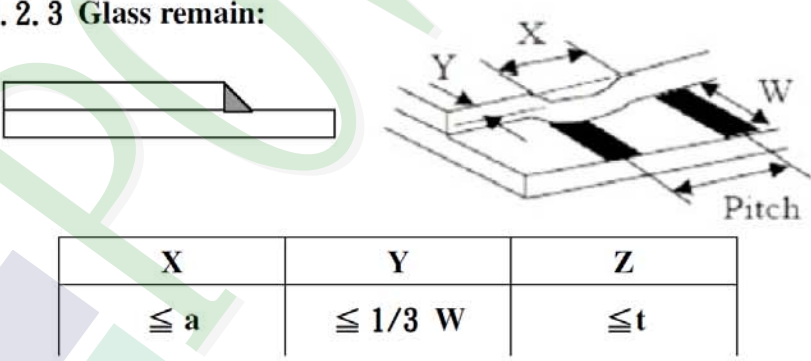
NO	Item	Criterion	Level												
08	The crack of glass	<p><b>Symbols :</b></p> <p><b>X:</b> The length of crack  <b>Z:</b> The thickness of crack  <b>t:</b> The thickness of glass</p> <p><b>Y:</b> The width of crack.  <b>W:</b> terminal length  <b>a:</b> LCD side length</p> <hr/> <p><b>8.1.2 Corner crack:</b></p>  <table border="1" data-bbox="533 757 1334 1043"> <thead> <tr> <th>X</th> <th>Y</th> <th>Z</th> </tr> </thead> <tbody> <tr> <td><math>\leq 1/5 a</math></td> <td>Crack can't enter viewing area</td> <td><math>Z \leq 1/2 t</math></td> </tr> <tr> <td><math>\leq 1/5 a</math></td> <td>Crack can't exceed the half of SP width.</td> <td><math>1/2 t &lt; Z \leq 2 t</math></td> </tr> </tbody> </table>	X	Y	Z	$\leq 1/5 a$	Crack can't enter viewing area	$Z \leq 1/2 t$	$\leq 1/5 a$	Crack can't exceed the half of SP width.	$1/2 t < Z \leq 2 t$				
		X	Y	Z											
$\leq 1/5 a$	Crack can't enter viewing area	$Z \leq 1/2 t$													
$\leq 1/5 a$	Crack can't exceed the half of SP width.	$1/2 t < Z \leq 2 t$													
		<p><b>8.2 Protrusion over terminal:</b></p> <p><b>8.2.1 Chip on electrode pad:</b></p>  <table border="1" data-bbox="571 1671 1343 1841"> <thead> <tr> <th></th> <th>X</th> <th>Y</th> <th>Z</th> </tr> </thead> <tbody> <tr> <td><b>Front</b></td> <td><math>\leq a</math></td> <td><math>\leq 1/2 W</math></td> <td><math>\leq t</math></td> </tr> <tr> <td><b>Back</b></td> <td><math>\leq a</math></td> <td><math>\leq W</math></td> <td><math>\leq 1/2 t</math></td> </tr> </tbody> </table>		X	Y	Z	<b>Front</b>	$\leq a$	$\leq 1/2 W$	$\leq t$	<b>Back</b>	$\leq a$	$\leq W$	$\leq 1/2 t$	Minor
	X	Y	Z												
<b>Front</b>	$\leq a$	$\leq 1/2 W$	$\leq t$												
<b>Back</b>	$\leq a$	$\leq W$	$\leq 1/2 t$												

NO	Item	Criterion	Level												
08	The crack of glass	<p><b>Symbols:</b></p> <p><b>X:</b> The length of crack  <b>Z:</b> The thickness of crack  <b>t:</b> The thickness of glass</p> <p><b>Y:</b> The width of crack.  <b>W:</b> terminal length  <b>a:</b> LCD side length</p> <hr/> <p><b>8.2.2 Non-conductive portion:</b></p>  <p style="text-align: center;"> <table border="1" style="margin-left: auto; margin-right: auto;"> <thead> <tr> <th>X</th> <th>Y</th> <th>Z</th> </tr> </thead> <tbody> <tr> <td style="text-align: center;"><math>\leq 1/3 a</math></td> <td style="text-align: center;"><math>\leq W</math></td> <td style="text-align: center;"><math>\leq t</math></td> </tr> </tbody> </table> </p> <p>⊙ If the chipped area touches the ITO terminal, over 2/3 of the ITO must remain and be inspected according to electrode terminal specifications.</p> <p><b>8.2.3 Glass remain:</b></p>  <p style="text-align: center;"> <table border="1" style="margin-left: auto; margin-right: auto;"> <thead> <tr> <th>X</th> <th>Y</th> <th>Z</th> </tr> </thead> <tbody> <tr> <td style="text-align: center;"><math>\leq a</math></td> <td style="text-align: center;"><math>\leq 1/3 W</math></td> <td style="text-align: center;"><math>\leq t</math></td> </tr> </tbody> </table> </p> <p><b>8.2.4 Cracking:</b></p>  <p style="text-align: center;"><b>Not Allowed</b></p>	X	Y	Z	$\leq 1/3 a$	$\leq W$	$\leq t$	X	Y	Z	$\leq a$	$\leq 1/3 W$	$\leq t$	Minor
X	Y	Z													
$\leq 1/3 a$	$\leq W$	$\leq t$													
X	Y	Z													
$\leq a$	$\leq 1/3 W$	$\leq t$													

**◆ Specification For TFT-LCD Module 3.5" ~15" :**

(Ver.B01)

NO	Item	Criterion	Level
09	Backlight elements	9. 1 Backlight can't work normally.	Major
		9. 2 Backlight doesn't light or color is wrong.	Major
		9. 3 Illumination source flickers when lit.	Major
10	General appearance	10. 1 Pin type 、 quantity 、 dimension must match type in structure diagram.	Major
		10. 2 No short circuits in components on PCB or FPC.	Major
		10. 3 Parts on PCB or FPC must be: no wrong parts, missing parts or excess parts.	Major
		10. 4 Product packaging must the same as specified on packaging specification sheet.	Minor
		10. 5 The folding and peeled off in polarizer are not acceptable.	Minor
		10. 6 The PCB or FPC between B/L assembled distance(PCB or FPC ) is $\leq 1.5$ mm.	Minor



## 5. PRECAUTION RELATING PRODUCT HANDLING

### 5.1 SAFETY

- 5.1.1 If the LCD panel breaks, be careful not to get the liquid crystal to touch your skin.
- 5.1.2 If the liquid crystal touches your skin or clothes, please wash it off immediately by using soap and water.

### 5.2 HANDLING

- 5.2.1 Avoid any strong mechanical shock which can break the glass.
- 5.2.2 Avoid static electricity which can damage the CMOS LSI—When working with the module, be sure to ground your body and any electrical equipment you may be using.
- 5.2.3 Do not remove the panel or frame from the module.
- 5.2.4 The polarizing plate of the display is very fragile. So, please handle it very carefully, do not touch, push or rub the exposed polarizing with anything harder than an HB pencil lead (glass, tweezers, etc.)
- 5.2.5 Do not wipe the polarizing plate with a dry cloth, as it may easily scratch the surface of plate.
- 5.2.6 Do not touch the display area with bare hands, this will stain the display area.
- 5.2.7 Do not use ketonics solvent & aromatic solvent. Use with a soft cloth soaked with a cleaning naphtha solvent.
- 5.2.8 To control temperature and time of soldering is  $320 \pm 10^{\circ}\text{C}$  and 3-5 sec.
- 5.2.9 To avoid liquid (include organic solvent) stained on LCM
- 5.2.10 Caution!( LCM products with Capacitive Touch Panel)  
Strong EMI-sources such as switch-mode power supplies (SMPS) can lead to touch malfunction (e.g. ghost-touches).  
Therefore, the touch needs to be thoroughly tested inside the target application.
- 5.2.11 CAUTION: Continuously displaying same static image will result in high possibility of image sticking/image burn-in effect due to TFT panel characteristic.
- 5.2.12 Double-sided tape designed to be attach with the customer's mechanical device, please follow up the rules and regulations published by the original manufacturer of double-sided tape for the attachment operation.

### 5.3 STORAGE

- 5.3.1 Store the panel or module in a dark place where the temperature is  $25^{\circ}\text{C} \pm 5^{\circ}\text{C}$  and the humidity is below 65% RH.
- 5.3.2 Do not place the module near organics solvents or corrosive gases.
- 5.3.3 Do not crush, shake, or jolt the module.

### 5.4 TERMS OF WARRANTY

- 5.4.1 Applicable warrant period The period is within thirteen months since the date of shipping out under normal using and storage conditions.
- 5.4.2 Unaccepted responsibility  
This product has been manufactured to your company's specification as a part for use in your company's general electronic products. It is guaranteed to perform according to delivery specifications. For any other use apart from general electronic equipment, we cannot take responsibility if the product is used in nuclear power control equipment, aerospace equipment, fire and security systems or any other applications in which there is a direct risk to human life and where extremely high levels of reliability are required.

A B C D E F G H

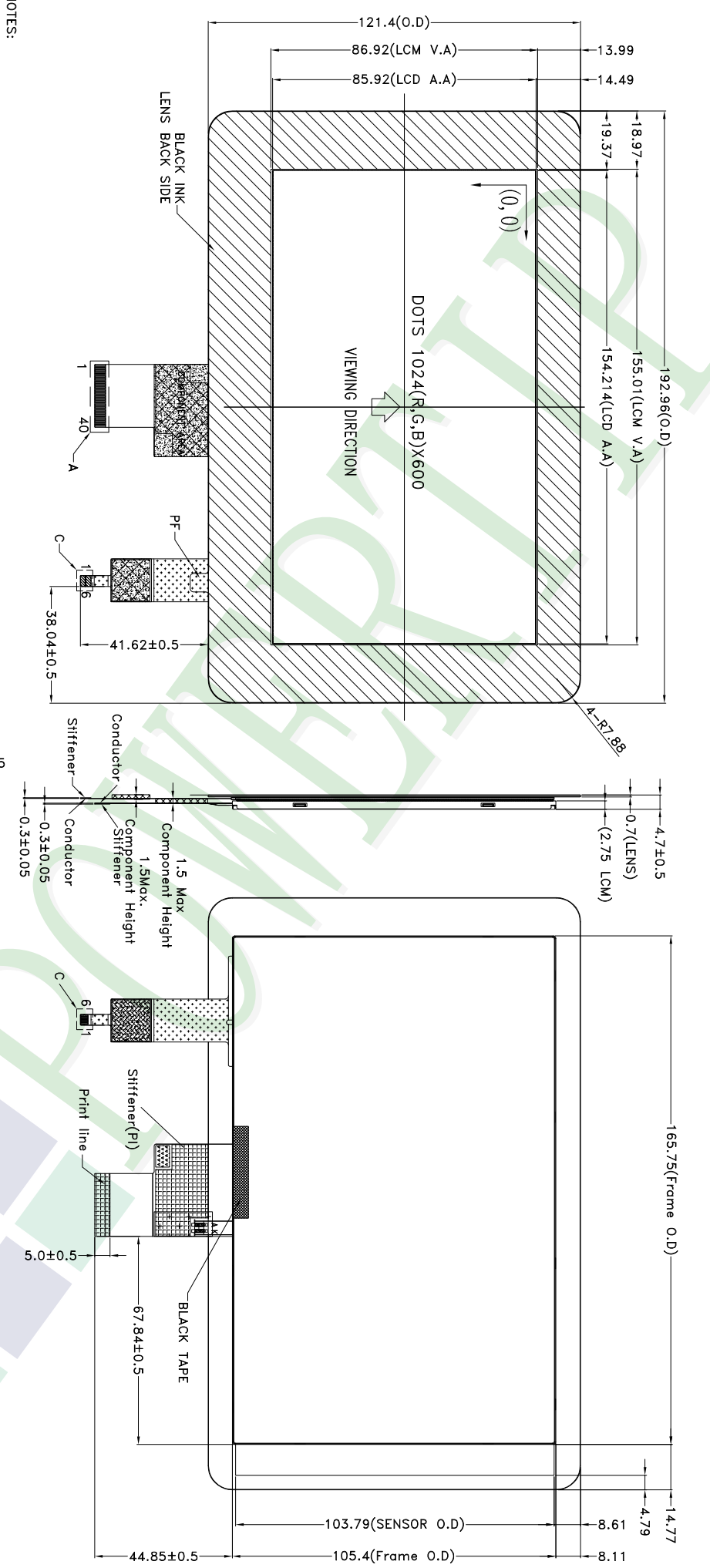

NOTES:  
 1. LCD TYPE: TFT LCD  
 2. LCD DISPLAY: Normally Black/TRANSMISSIVE  
 3. The tolerance unless classified ±0.3mm  
 4. B/P: 0.5X39=19.5±0.05; W=0.3±0.05  
 5. : FPC Component Area & Unbending area;  
 : GND; : Kapton tape; : MI Film;  
 : Stiffener(SUS t=0.2mm to GND)  
 6. FPC suggested connector: HIROSE FH12A-40S-0.5SH or compatible  
 TP FPC suggested connector: HIROSE FH34S-6S-0.5SH or compatible

久正光电股份有限公司  
 POWER TIP TECHNOLOGY CORPORATION

001	NEW DRAWING	REVISION	REV	2021/10/14	DATE	Tina	REVISER
002							
003							
004							
005							
006							
007							

PART NO:		PH102600T013-ZFC04	
DRAWING NAME:		LMD-PH102600T013-ZFC04	
TITLE:		LCD MODULE DRAWING	
Design	Check	Approve	
Tina Chen	Clare Chen	Rex Liao	

Precision Level	Resolution (mm)		Scale
	1 ~ 4	4 ~ 16	
	16 ~ 63	63 ~ 250	
	250 ~ 1000		

PT-A-054-01

# LCM包裝規格書

## LCM Packaging Specifications

Approve	Check	Contact
Rex	Clare	Tina

### 1. 包裝材料規格表 (Packaging Material) : (per carton)

No.	Item	Model	Dimensions (mm)	1Pcs Weight	Quantity	Total Weight
1	成品 (LCM)	PH102600T013-ZFC04	192.96 X 121.4	0.164	60	9.84
2	靜電袋(1)Antistatic Bag	BAG240170ARABA	240 X 170	0.0048	60	0.288
3	氣泡袋(2)Bubble Bag	BAG200160BRABA	200 X 160	0.0096	60	0.576
4	A9隔板(3)A9 Partition	BX00000000058	245 X 125 X 4	0.0204	36	0.7344
5	B9隔板(4)B9 Partition	BX00000000057	295 X 125 X 4	0.0209	8	0.1672
6	海綿墊(5)Foam Rubber Cushion	OTFOAM00006ABA	290 X 240 X 10	0.02	8	0.16
7	C5內盒(6)Product Box	BX00000000059	310 X 255 X 155	0.248	4	0.992
8	外紙箱(7)Carton	BX52732536CCBA	527 X 325 X 360	0.83	1	0.83
9	保麗龍板(8)Polylon board	OTPLB00000017	510 X 310 X 15	0.025	3	0.075

2. 一整箱總重量 (Total LCD Weight in carton) : 13.66 Kg±10%

3. 單箱數量規格表 (Packaging Specifications and Quantity) :

(1)Quantity Of Spacer : A9隔板 X 9 , B9隔板 X 2

(2)Total LCM quantity in carton : quantity per box 15 x no of boxes 4 = 60

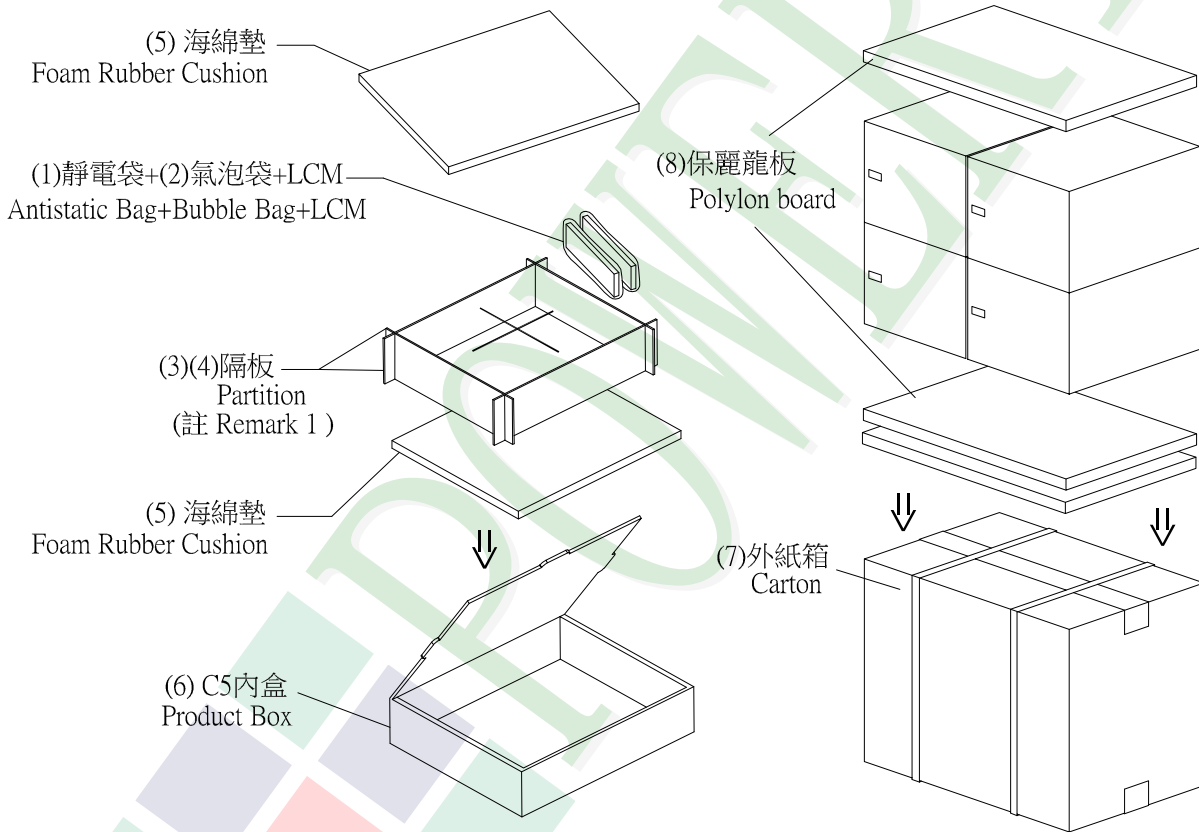

### 特記事項 (REMARK)

4. LCM排放示意圖(前後間隔不放置):

4. LCM placed as figure showing:  
( First and last slot should be empty)

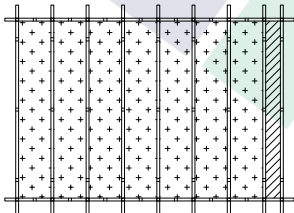

▤ 模組(LCM) X 2pcs.

▨ 模組(LCM) X 1pcs.